

RF Testing of Wireless LAN Products

Application Note 1380-1

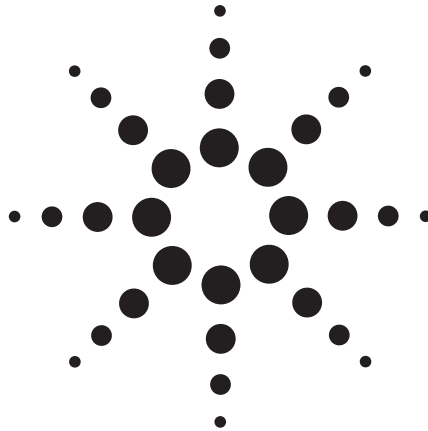

Introduction

Wireless Local Area Networks allow mobile computer users to remain connected to a network, and access resources, while on the move or physically disconnected from the network. Over the past several years, different Wireless Local Area Network (WLAN) technologies and standards have been developed. Two of the major driving forces behind these standards are the Institute of Electrical and Electronic Engineers (IEEE) and the European Telecommunications Standards Institute (ETSI). From these organizations have emerged two of the most successful WLAN standards, IEEE 802.11 and ETSI HIPERLAN. Recent advances in technology have enabled the production of affordable and reliable networking hardware for use in wireless LANs.

The acronyms used in this document are either defined at their first usage or in the glossary on page 38.

This application note looks at the modulation technology behind several wireless LAN standards and the measurement techniques that can be used to troubleshoot and quantify their RF performance. The emphasis will be on the newest and most successful of these standards: 802.11b, 802.11a, and HIPERLAN Type 1 and Type 2. The principal focus of this document is the physical RF layer of wireless LAN signals, as opposed to the MAC layer or higher layers of a WLAN signal. This includes time-, frequency-, and modulation-domain analysis and trouble-shooting, as well as the basic modulation theory behind these standards.

Various modulation schemes are implemented in the standards, and this document includes information on FSK, MSK, GMSK, CCK, and OFDM modulation.



Agilent Technologies

Table of Contents

1.	HIPERLAN Type 1	3
1.1	FSK modulation	3
1.2	GMSK modulation	6
1.3	GMSK demodulation	8
2.	802.11 and 802.11b	10
2.1	802.11	10
2.2	802.11b	12
2.3	Modulation analysis of 802.11b signals	13
3.	802.11a and HIPERLAN Type 2	24
3.1	OFDM signals	24
3.2	Dealing with multipath	29
3.3	Modulation analysis of an OFDM signal	31
4.	Conclusion	37
	Acronym glossary	38
	Wireless LAN standards summary table	39
	Related literature	39

1. HIPERLAN Type 1

1.1 FSK Modulation

HIPERLAN Type 1 uses two different modulation formats: a simple 2-level FSK format for low-rate data, and 0.3 GMSK for high-rate data. Since 2-level FSK is the simplest modulation format discussed in this application note, it is an appropriate place to start.

The 2-level FSK format uses a symbol rate of 1.4705875 Mbit/s. In this case this is also the bit rate. The data is used to produce a RECT-filtered signal, which may be passed through another low-pass filter to limit the signal spectrum. The low-pass filtered signal is then fed to a FM modulator with a frequency deviation of ± 368 kHz. The transmitter filters must be carefully designed, because

narrow filters will help contain the spectrum, but they will also slow down the frequency transitions between symbols.

Figure 1.1.1 shows a screen plot from an Agilent Technologies 89640A Vector Signal Analyzer (VSA) with the characteristics of the 2-FSK signal. The upper left grid is the FM demodulated signal. The lower left grid shows the spectrum of this particular signal, which was generated by an Agilent Technologies E4433B Electronic Signal Generator (ESG). The instrument span is set to 18 MHz. The choice of span involves trading off the noise bandwidth of the measurement with the speed of the symbol transitions. Using a wider span introduces more noise into the

measurement and narrower spans eliminate higher frequency components in the signal and increase the duration of the FSK transitions. The specification calls for a 50 nsec transition, as will be shown later. To measure this transition, the span should not be much less than 1/50 nsec, or 20 MHz. The upper right diagram shows the eye diagram. The markers are spaced about 68 nsec apart. The lower right trace contains summary information and is one of the most useful traces. It contains the raw bits, the deviation, the FSK (FM) error, and the carrier frequency offset. The FSK error is a RMS measure of the residual FM error normalized by the deviation.

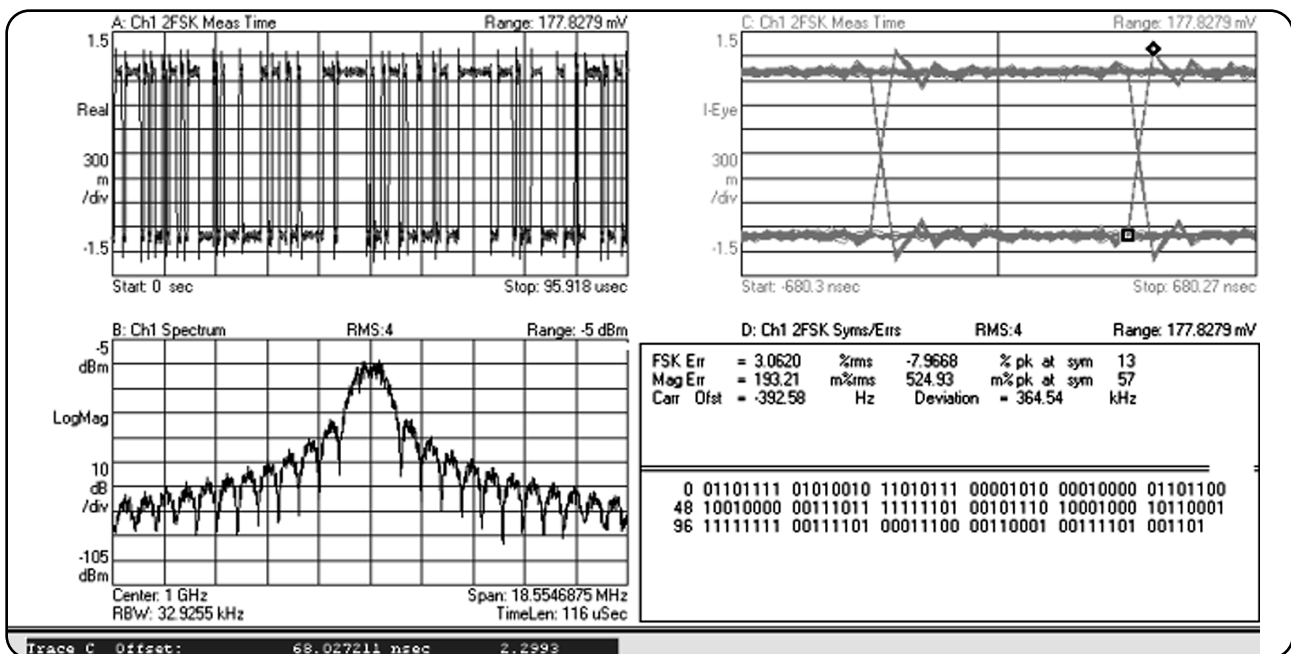

Figure 1.1.1: 2-FSK signal characteristics

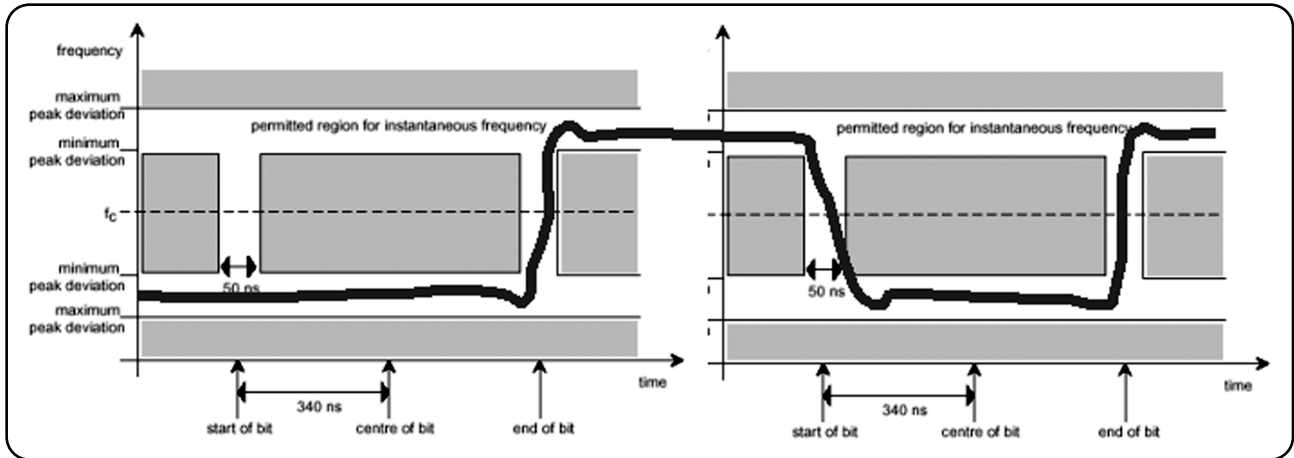

Figure 1.1.2: Eye-diagram mask for low-rate FSK modulation

Figure 1.1.2 shows a typical eye-diagram mask. The eye-diagram mask serves two purposes. First, it places limits on the deviation and second, it places limits on the speed of the symbol transition. Taking the signal two symbols at a time and overlaying them one on top of the other creates an eye diagram.

Important FM modulator characteristics that affect the eye-diagram are deviation, modulator bandwidth, filter characteristics, and frequency stability. If the modulator bandwidth is insufficient, the rise/fall times will be too slow. The baseband and IF filters can also cause this problem as well as overshoot and ringing.

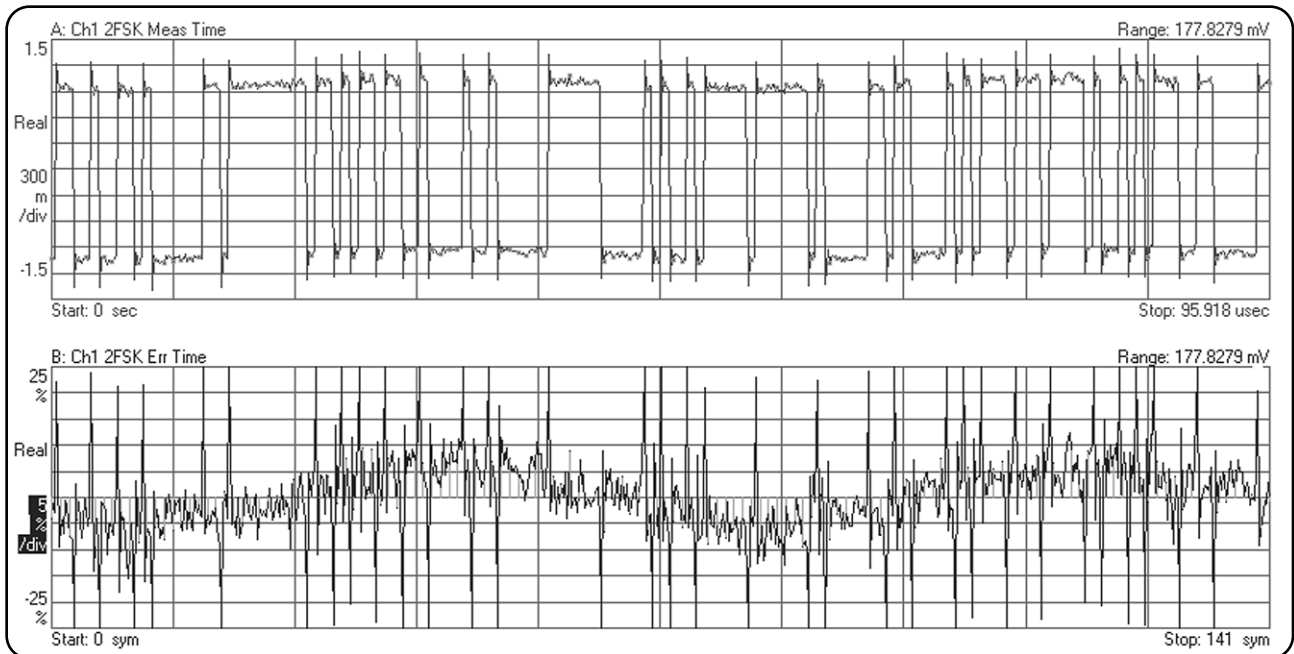

Figure 1.1.3: Residual FM on a FSK waveform

Residual FM is undesired FM modulation caused by spurious signals getting into the modulator. For example, in Figure 1.1.3, the Agilent E4433B ESG's FM modulator was used to add a 20 kHz (rate and deviation) FM signal to the FSK waveform. The sinusoidal error is shown in the lower trace. The error is large enough that you can actually see the entire FSK signal moving up and down.

Some FM modulators have a baseline drift problem. This can occur, for example, when several identical bits are sent in a row (e.g. 3 ones). The carrier frequency drifts in a positive direction for a sequence of ones and in a negative direction for a sequence of zeros. It is easily detected by looking at the FM signal plot with the FSK error plot, as configured above.

1.2 GMSK Modulation

For high-rate data, HIPERLAN Type 1 uses a 23.5294 Mbit/s GMSK signal. There are two ways to generate the GMSK signal. The first method uses a FM modulator, as shown in Figure 1.2.1. A mistake that designers often make when working with baseband signals is exciting the baseband filter with RECT pulses instead of Dirac deltas. The use of RECT pulses is equivalent to adding a second filter, whose response is a rectangular impulse, T seconds wide. This causes the baseband spectrum to have an extra $\sin(x)/x$ roll off.

While simple to implement, the use of an FM modulator for GMSK is usually not a good idea as it requires the use of coherent demodulators. Coherent demodulators require excellent phase control. Recognizing this, the ETSI modulation quality measurement for this signal is a measure of the RMS phase error, just as it is for GSM. The problem with a FM modulator is controlling the frequency deviation. Ignoring ISI, the frequency deviation needs to be exactly $1/4$ th of the symbol rate to produce a 90 degree phase rotation in one symbol interval. In systems where non-coherent receivers are used, this modulation

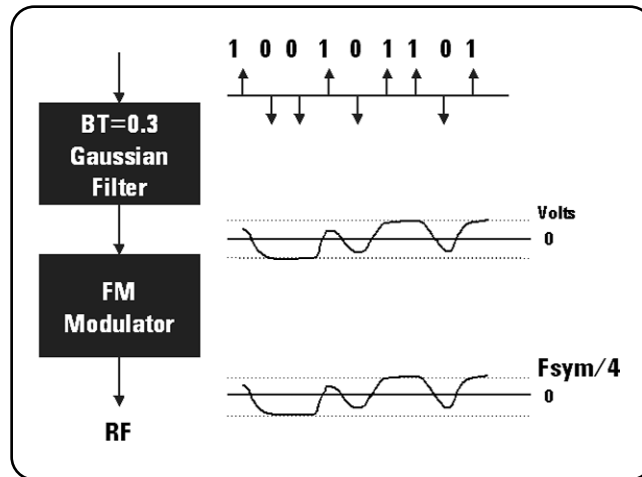

Figure 1.2.1: GMSK modulation method 1

is referred to as GFSK (as in 802.11 2- and 4-level GFSK). For GFSK, the deviation is not strictly limited to $1/4$ th of the symbol rate.

It is worth noting that the 0.3 Gaussian filter is not zero-ISI, as can be seen by the frequency trajectory for 1-0-1 or 0-1-0 transitions. Only when two identical bits are sent in a row does the signal reach full deviation.

The second approach to GMSK modulation is to run the signal representing frequency into an integrator, shown in Figure 1.2.2, which creates a signal that represents phase and then passed to a phase modulator – usually implemented using an I/Q modulator. Normally, everything up to the I/Q modulator will be done in DSP. Relative to the FM modulator approach, this method for generating GMSK signals has well-controlled phase.

There is little to go wrong with this approach prior to the I/Q modulator, with the possible exception of integration errors (and the inadvertent use of a RECT filter), because the signal has a constant envelope. The majority of the analog problems are with the I/Q modulator or the local oscillators. Errors that may contribute to RMS phase error include LO feed through, gain and phase imbalance, LO phase noise, and spurious signals.

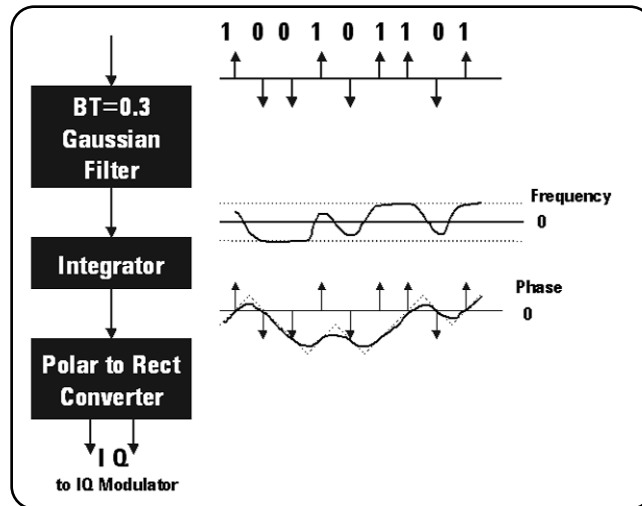

Figure 1.2.2: GMSK modulation method 2

1.3 GMSK Demodulation

Figure 1.3.1 shows a plot of the Agilent 89640A VSA measuring a 23.5294 Mbit/s GMSK signal. This signal was intentionally generated with 5 degrees of quadrature skew. The Agilent 89640A VSA has 36 MHz of information bandwidth, which is sufficient to measure the signal. The main lobe of the spectrum, about 33 MHz wide, is visible in the lower left grid.

The upper left grid shows the constellation. The oval shape of the polar plot clearly shows the quadrature skew. The dots on the

perimeter of the oval represent the symbol points and are spaced every 90 degrees as expected. A closer inspection reveals that there are actually 4 clusters of 3 symbol dots. The 3-dot areas are a result of the ISI introduced by the Gaussian filter.

The upper right grid is a plot of the phase error, shown over 200 symbols. The waveform represents the difference between the measured carrier phase trajectory and the ideal phase trajectory, computed using the detected bits. The RMS of this phase-error signal is the modulation quality metric.

The lower right grid shows the RMS phase error as approximately 2 degrees (the allowable limit is 10 degrees) and a peak phase error of 3 degrees (the allowable limit is 30 degrees). The table also reports that there are 4.6 degrees of quadrature skew and 0.25 dB of gain imbalance. While there are no limits set on skew and imbalance in the standard, it is useful to know what these numbers are, since these errors contribute to the phase error metric.

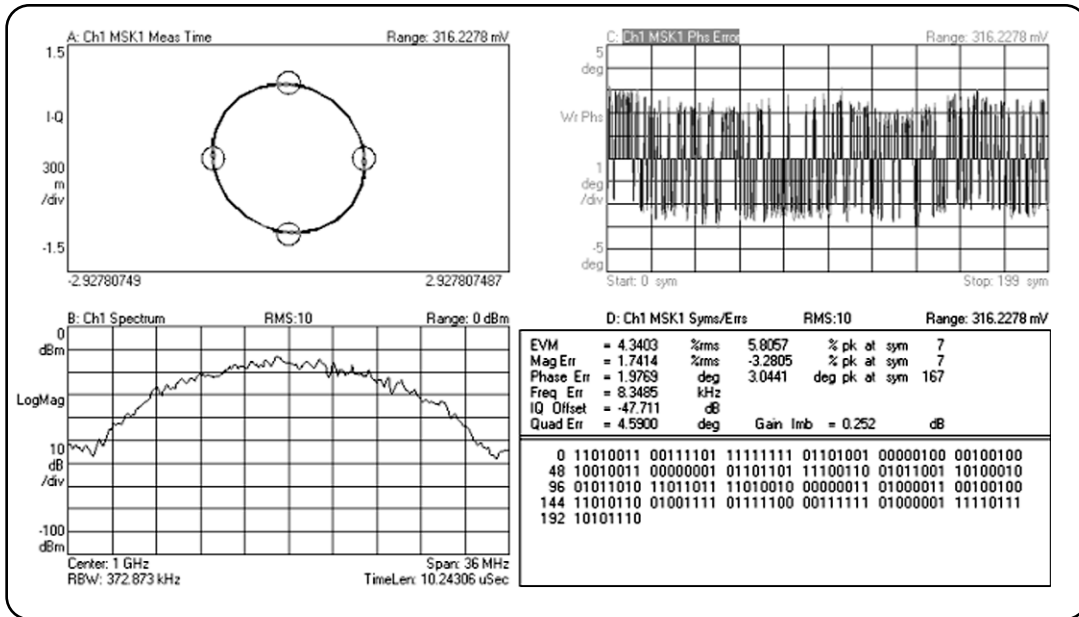

Figure 1.3.1: GMSK signal demodulation

The Agilent 89640A VSA includes 2- and 4-level FSK demodulators. These are useful for GFSK waveforms such as those found in 802.11. The GFSK demodulator can also be used on GMSK waveforms, like the high-rate signal in HIPERLAN Type 1. Errors such as carrier frequency instability, or settling, are easier to see as a FM error than they are as a phase error. The FM (or FSK) error is the difference between the measured frequency trajectory and the ideal frequency trajectory based on the demodulated bits.

Figure 1.3.2 shows (top to bottom, left to right) a display of the FSK eye diagram, the FM waveform over 20 symbols, the FM error over those same 20 symbols, and the summary table with information such as carrier frequency offset and deviation. As expected, the deviation is 1/4th of the symbol rate. Notice how the ISI created by the Gaussian filter produces six levels in the eye diagram. This signal is obviously more heavily filtered than the low-rate FSK signal.

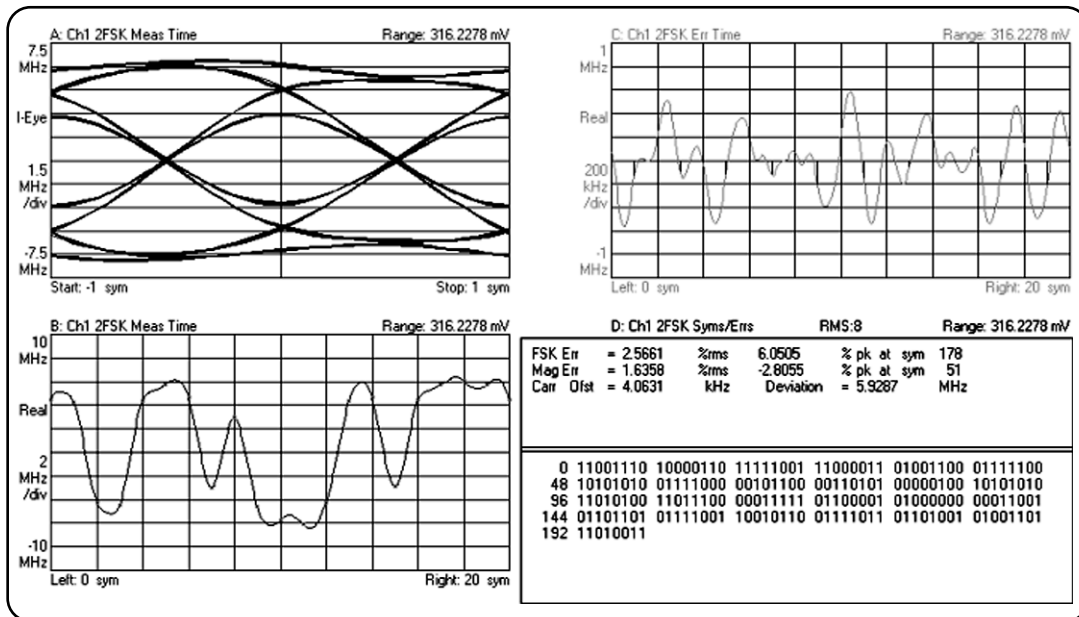

Figure 1.3.2: GMSK signal demodulated as a GFSK signal

2. 802.11 & 802.11b

2.1 802.11

The original 802.11 standard supports data rates at 1 Mbit/sec and 2 Mbit/sec. This is done through 2- and 4-level GFSK frequency hopping spread spectrum (FHSS), or through BPSK and QPSK direct sequence spread spectrum (DSSS). This section will focus on DSSS.

In spread-spectrum communications, the signal bandwidth is increased (in this case of DSSS, by a factor of 11)

without increasing the data rate. This is done to increase immunity toward interference from hostile microwave ovens, multipath, and co-channel signals. Spread spectrum technology allows the chip rate to remain constant while the data rate changes to match conditions. For example, the 1Mbit/sec rate has a spreading factor of 11, using BPSK modulation. QPSK replaces BPSK in order to double the bit rate to 2 Mbit/sec, at the same spreading rate of 11.

As shown in Figure 2.1.1, to create a DSSS signal, a lower rate signal is multiplied by a higher rate signal. For 1 Mbit/sec, the 1 MHz (D)BPSK signal is multiplied by an 11 MHz BPSK signal. Although not generally true of DSSS signals, for this particular signal it can be said that the input bits determine the phase rotation of the spreading code or that it is a (D)BPSK data signal spread by a BPSK spreading sequence, producing a BPSK constellation.

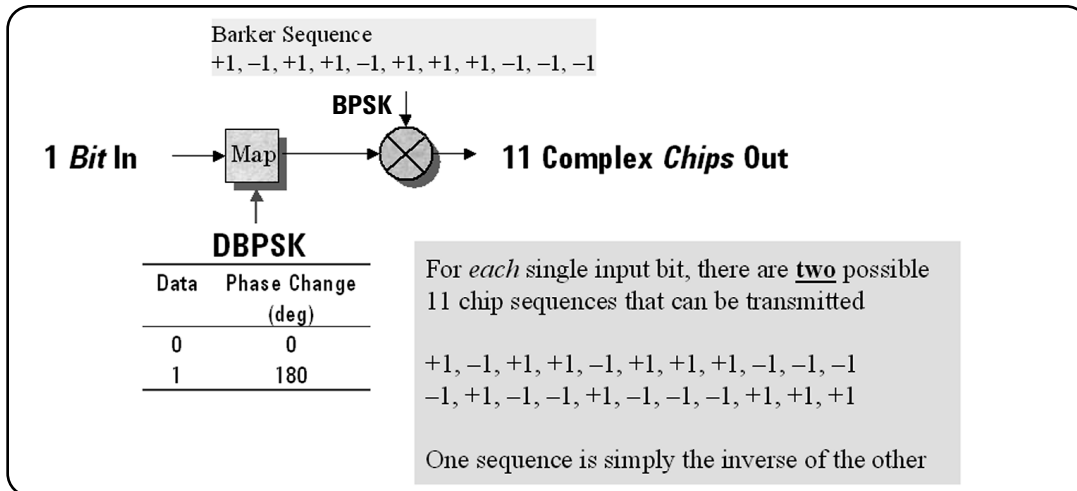

Figure 2.1.1: DSSS signal spreading for 1 Mbit/sec data rate

While any spreading sequence could be used, sequences are usually chosen for their spectral properties and for low cross correlation with other sequences likely to interfere. For 1 and 2 Mbit/sec 802.11, an 11-chip Barker sequence, is used. The value of the autocorrelation function for the Barker sequence is 1, -1, or 0 at all offsets except zero, where it is 11. This makes for a more uniform spectrum, and better performance in the receivers.

To double the bit rate from 1 Mbit/sec to 2 Mbit/sec, the bits are taken two at a time. The phase rotation now has four rotations: 0, 90, 180 and 270 degrees, instead of being either 0 or 180 degrees. The symbol rate remains at 1 Msym/sec. This can be thought of as a (D)QPSK signal spread by a BPSK signal to produce a QPSK signal.

As mentioned previously, at 1 Mbit/sec, an 11-chip Barker sequence with two-phase rotations is used to produce one symbol with two-phase states. At 2 Mbit/sec, the same sequence is used with four phase rotations in order to produce one symbol with four phase states. If this

approach were extended, 2048 rotations of an 11 bit sequence would be needed for a data rate of 11 Mbit/sec specified in 802.11b. Obviously, a different approach is needed.

While it would be possible to use some form of a QAM constellation instead of PSK, this would have the undesirable side effect of increasing the peak-to-average ratio of the signal, making amplification more difficult. The solution, used in 802.11b, is to retain a QPSK constellation at the transmitter output. The result is CCK, or Complementary Code Keying. The complementary codes are a set of nearly orthogonal complex sequences.

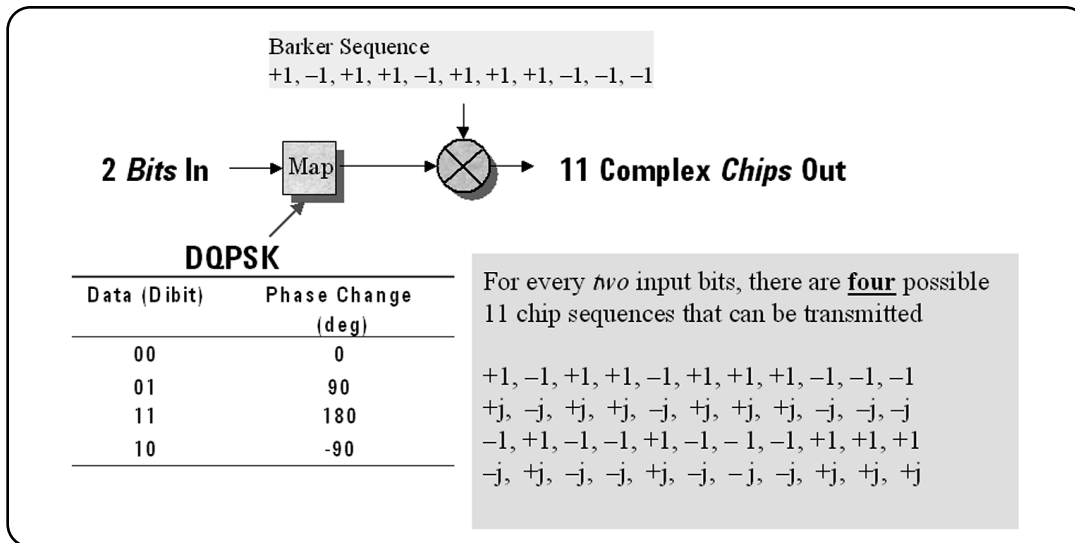

Figure 2.1.2: DSSS signal spreading for 2 Mbit/sec data rate

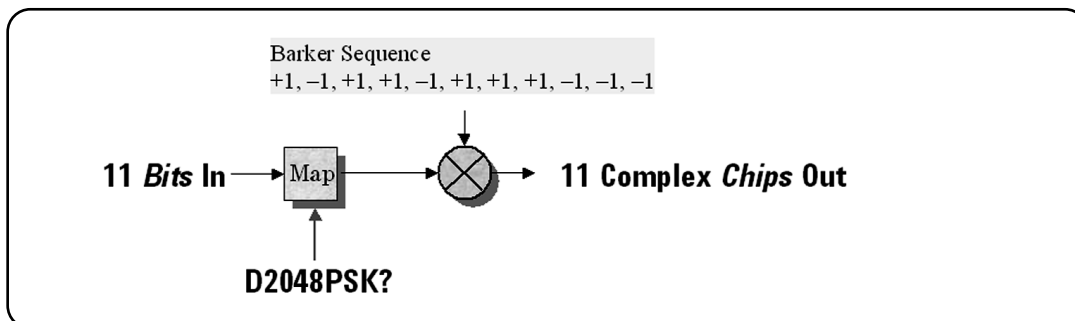

Figure 2.1.3: Complications arise when trying to achieve an 11 Mbit/sec data rate

2.2 802.11b

The 802.11b adds 5.5 Mbit/sec and 11 Mbit/sec data rates to the 802.11 standard. In a rather odd twist, the progression of technology in the 802.11 standard is 802.11 to 802.11b to 802.11a, and eventually to 802.11g, which at the time of this application note, has not been defined. Many find the fact that 802.11b is slower than 802.11a confusing.

The 802.11b, like 802.11 described in the previous section, is designed for use in the 2.4 GHz ISM band. The technology behind 802.11b is direct sequence spread spectrum using complementary code keying (CCK). Changing both the

spreading factor and/or the modulation format varies the bit rate.

To achieve 5.5 and 11 Mbit/sec rates, the spreading length is first reduced from 11 to 8. This increases the symbol rate from 1 Msym/sec to 1.375 Msym/sec. To achieve 5.5 Mbit/sec bit rates using the 1.375 MHz symbol rate, one needs to transmit $5.5/1.375$ or 4 bits/symbol. For 11 Mbit/sec one obviously needs 8 bits/symbol.

The approach taken for 802.11b, which keeps the QPSK spread spectrum signal and still provides the required number of bits/symbol, uses all but two of the bits to select from a set of spreading

sequences. It uses the remaining two bits to rotate the sequence. This is illustrated in Figure 2.2.1.

An important difference between the sets of spreading sequences used here and the single Barker code sequence used for the 1 and 2 Mbit/sec rates is that these sequences are complex. In other words, the signal is a (D)QPSK signal with QPSK spreading.

For all 802.11b bit rates, the preamble and header are sent at the 1 Mbit/sec rate. The header is 192 μ sec long (192 bits). This translates to a total of 2112 chips. The payload data is then appended using one of the four modulation rates.

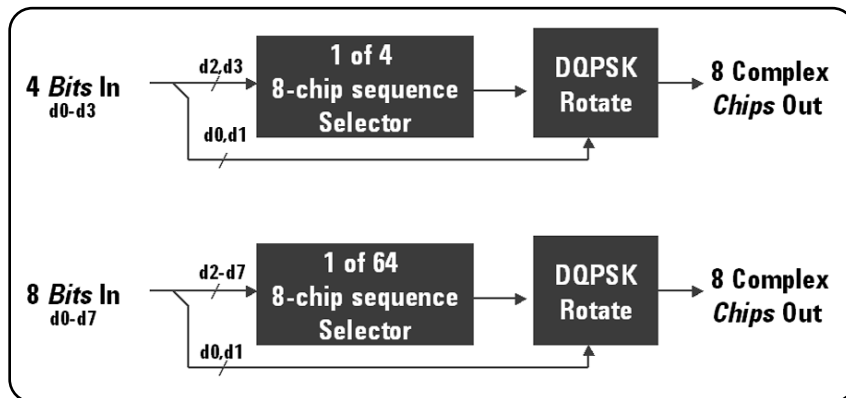

Figure 2.2.1: CCK modulation

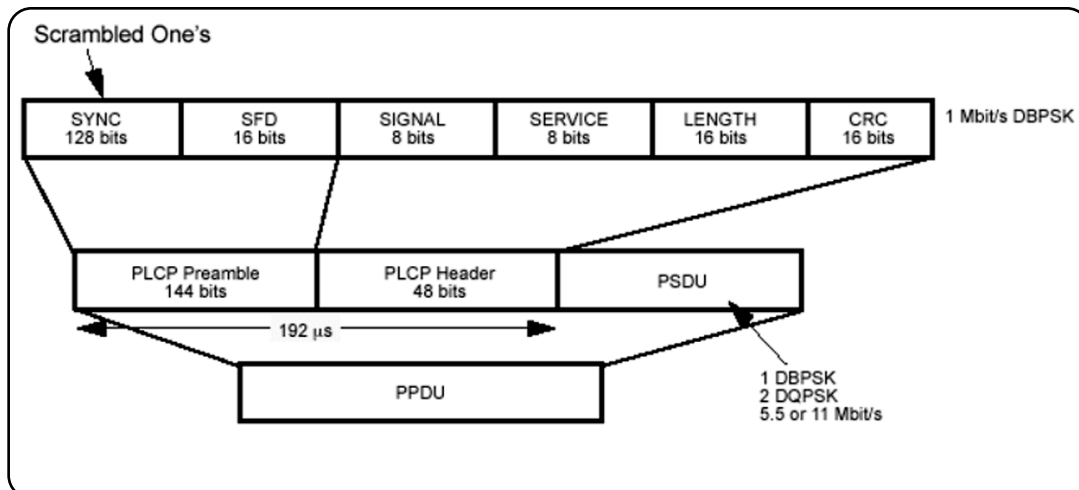

Figure 2.2.2: 802.11b PPDU components

2.3 Modulation analysis of 802.11b signals

The 20MHz wide bandwidth of WLAN signals make power envelope measurements difficult, as most spectrum analyzers have resolution bandwidth filters that are usually limited to less than 10 MHz. This means the signal is heavily filtered by the time it gets to the power detector. People often resort to diode detectors and oscilloscopes to look at these signals, but this approach provides limited dynamic range, and no frequency selectivity. Peak-power meters may provide more dynamic range, but they generally do not

have bandwidths that are well matched to this signal. The Agilent 89640A VSA has an information bandwidth of 36 MHz, making it ideal for time-domain analysis of wireless LAN signals. The information bandwidth is the widest bandwidth that can be digitized without loss of signal information, and is independent of the frequency tuning range.

Shown in Figure 2.3.1 is a plot of a power-versus-time measurement of a Brand-X Wi-Fi certified modem purchased on the open market. Several things are immediately noticeable from the plot. The most obvious is

the transition from the BPSK preamble/header to the higher rate modulation at the end of the burst. The transition is obvious because the QPSK signal has few chip transitions which cause the carrier to pass through the origin. The origin in a polar plot represents zero carrier power. In the plot, band-power markers, indicated by the solid vertical lines, are 192 μ sec apart. According to the standard, this should be the entire length of the preamble/header. It appears that the power amplifier or DSP is coming on late and thus shortening the sync portion of the preamble.

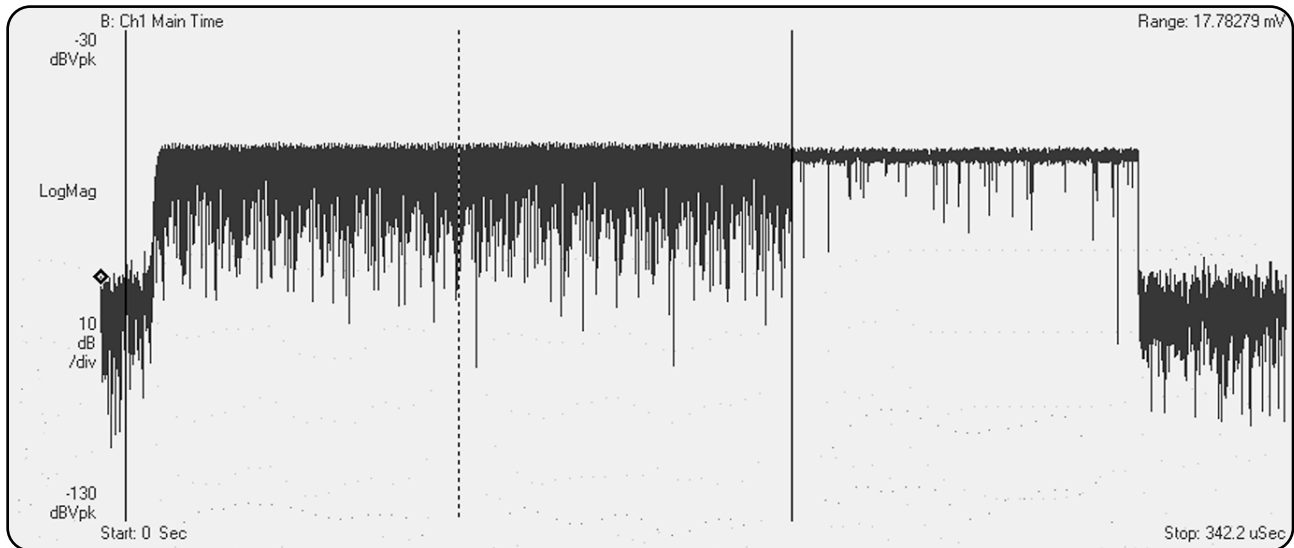

Figure 2.3.1: Power envelope of an 802.11b signal, showing preamble and header

Figure 2.3.2 shows the next burst out of the modem. Both bursts were captured in the analyzer's time-capture memory. This burst, which has a longer data segment, also comes much closer to having a full-length preamble.

The measurement shown in Figure 2.3.3 is interesting because the power-envelope display in the lower grid indicates that the power

is coming on in two steps. Not shown in the plot is the fact that the first step occurred 192 μ sec from the end of the preamble/header.

The Agilent 89640A VSA has the ability to make gated spectrum measurements. The gate interval and position can be adjusted before or after the measurement data is acquired. With gate markers positioned over the

sync portion of the burst, it is obvious that the spectrum does not exhibit a smooth $\sin(x)/x$ shape. This is normal and is caused by the relatively short Barker sequence. The spacing of the ripple will generally have some multiple of 0.5 MHz and is data dependent.

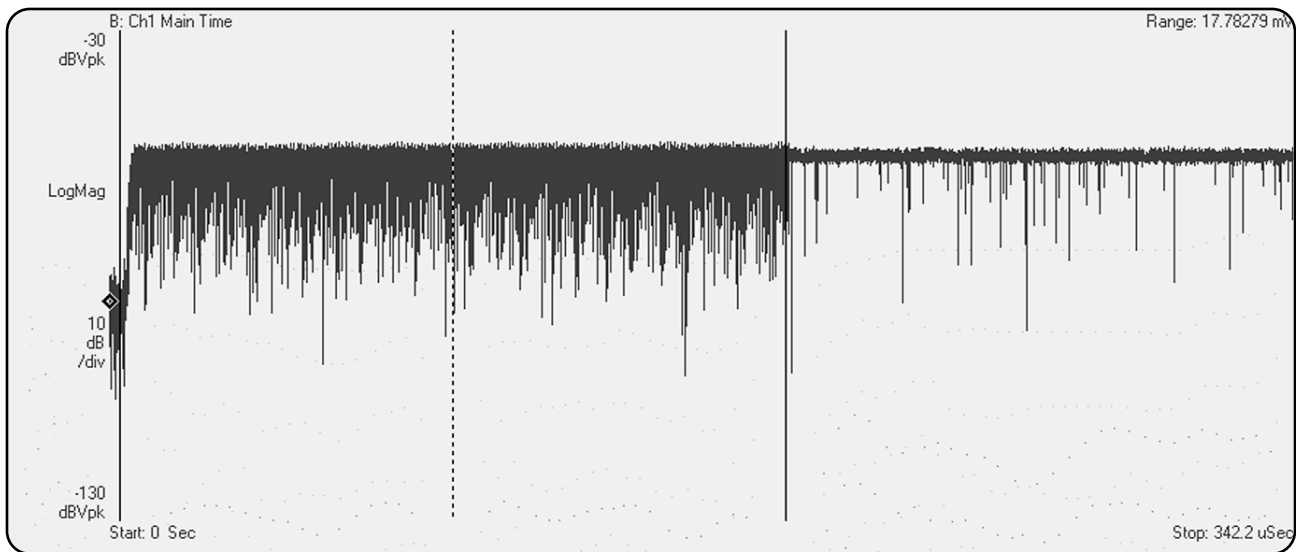

Figure 2.3.2: 802.11b burst with longer data segment

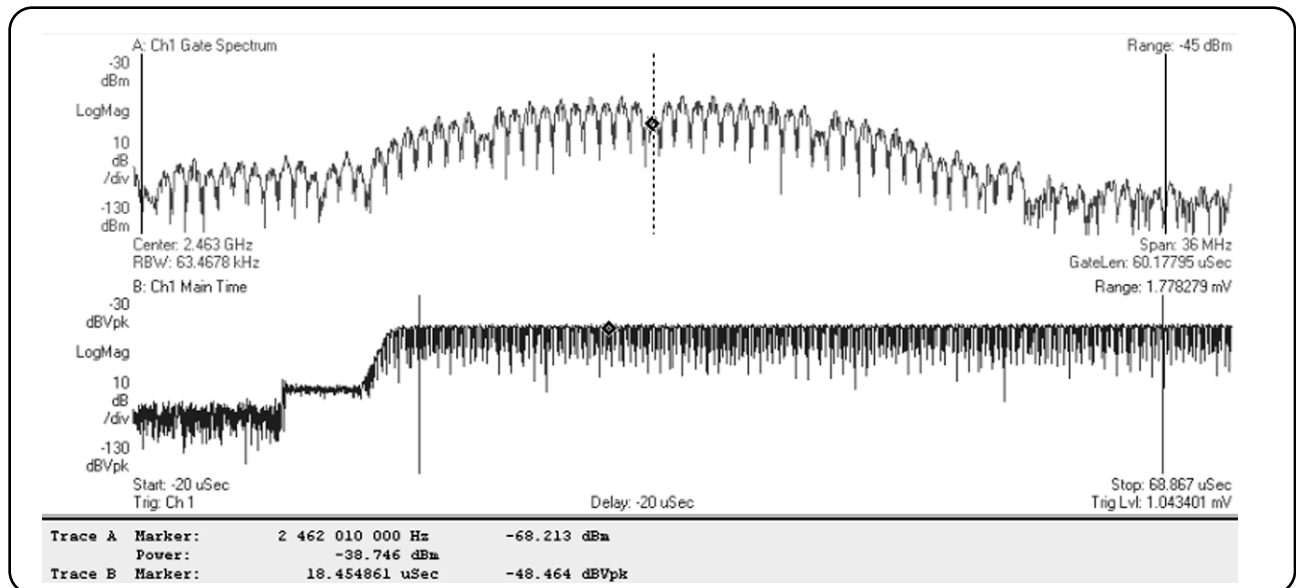

Figure 2.3.3: Gated spectrum analysis of power-up of an 802.11b signal

Without taking a new measurement, the gate markers can be moved to analyze the first step in the turn-on transient. It can be seen in Figure 2.3.4 that the first step is not modulated. The most likely cause of this is the power amplifier being turned on before the baseband signal processing. This is likely because the gated spectrum, shown in the top half of the figure, reveals a single tone – carrier leakage – and no modulation. With this information, it is known that the power amplifier is coming on at the right time, so the DSP is shortening the sync portion of the burst.

Based on the (spectral) band power measurement in the previous figure, the average signal power is -38.75 dBm in this over-the-air measurement. The marker on the carrier leakage is at -72.5 dBm making the carrier leakage about -34 dBc. This number will come up again during signal demodulation.

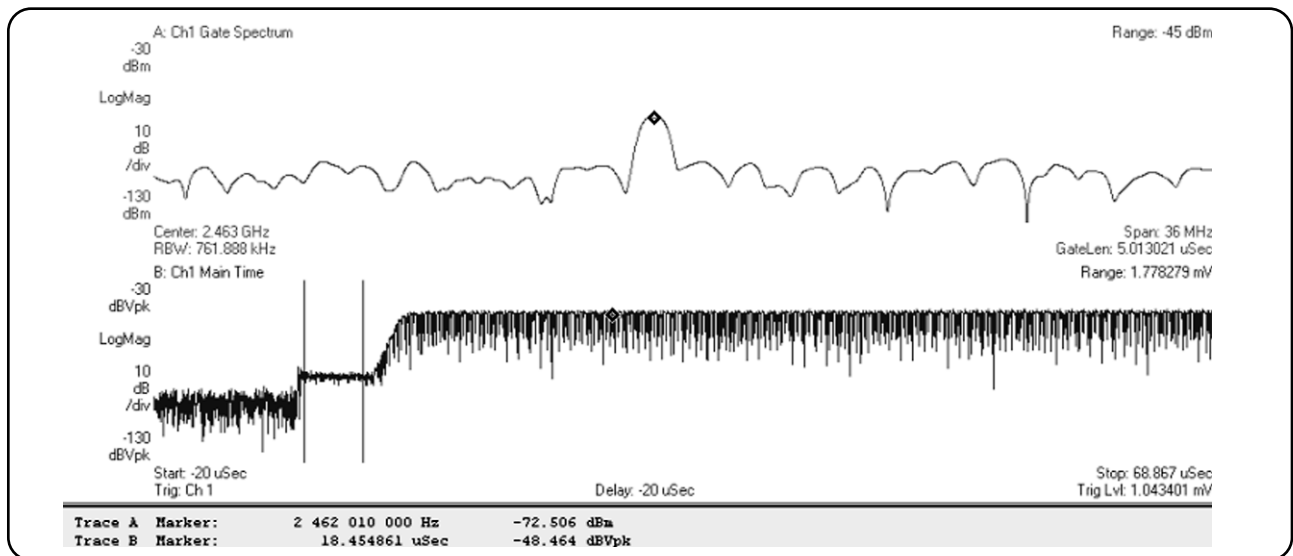

Figure 2.3.4: Investigating anomalies in a power burst through gated spectrum analysis

So how does this signal perform relative to the 802.11b mask? Since the mask is drawn on a linear scale, one needs to look at the signal on a linear scale. The upper grid in Figure 2.3.5 is an expanded view of what was seen in Figure 2.3.4 shown in logarithmic units. The lower trace is exactly the same except that it is displayed in linear units.

the shaping appears to be done in DSP. When special test modes are used to test the pulse shape there is always the possibility that the "special test software" could produce a result that is different than the "real software". Figure 2.3.5 still provides a good idea of how well the pulse is formed, even without a test mode.

One problem with this measurement, as described in the 802.11b standard, is that the limits do not take into account data modulation. This implies a special test mode. For this signal

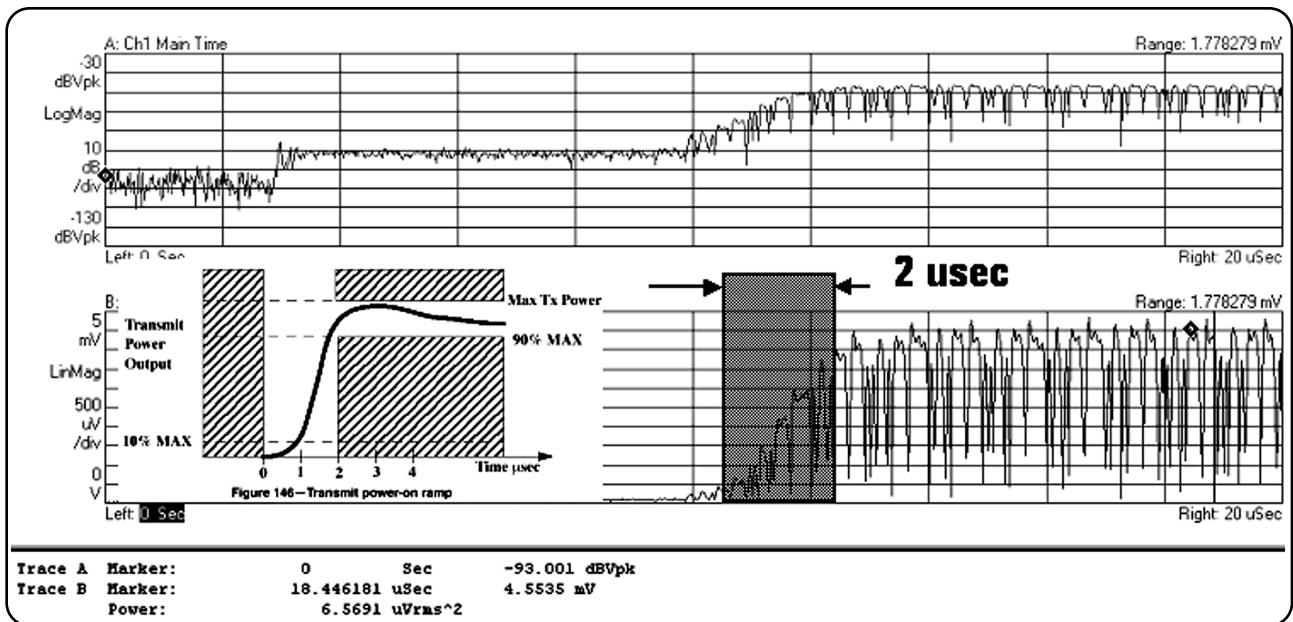

Figure 2.3.5: 802.11b power-up-envelope mask

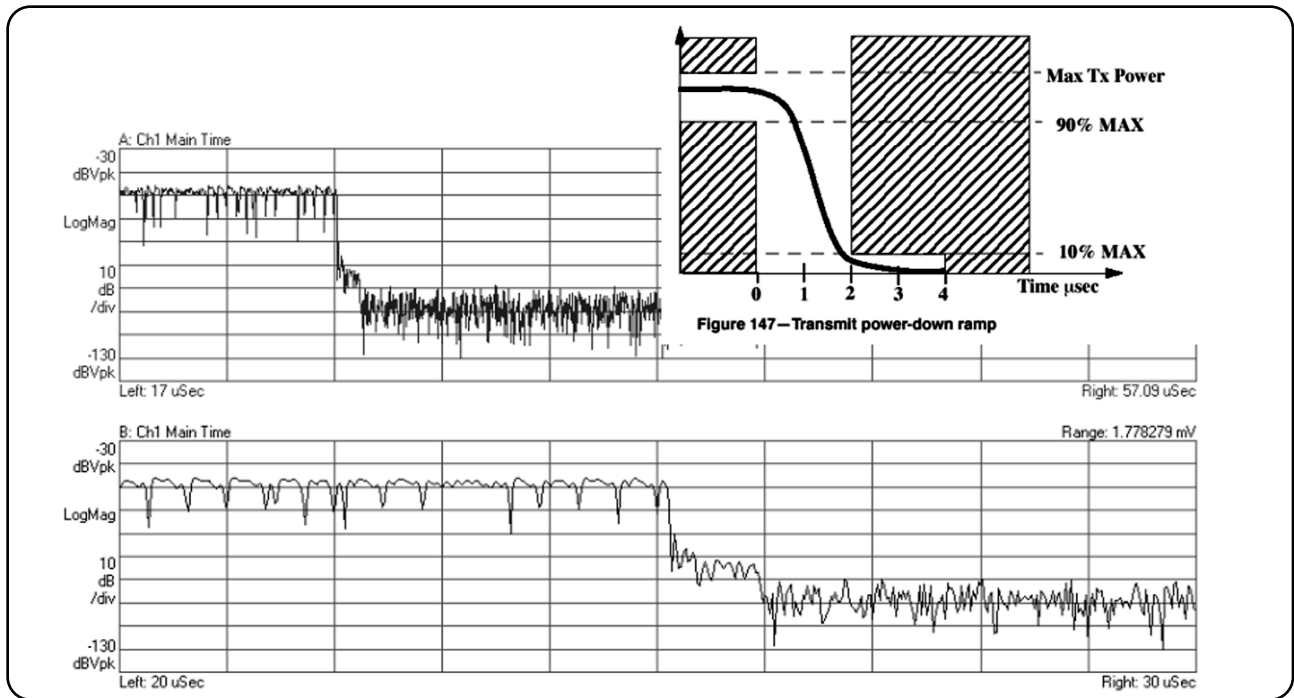

Figure 2.3.6: 802.11b power-down-envelope mask

The same carrier leakage term is evident when the signal turns off. It is interesting to note that the pulse shaping performed at the beginning of the burst doesn't appear at the end of the burst. This could cause a problem because fast transitions cause spectral splatter. It does not matter if it is a transition from off-to-on, or on-to-off. In turn-on and turn-off transitions, the standard does not dictate the exact location of the mask. This is rather unusual, and could cause compatibility problems.

The 802.11b standard does not specify a transmit filter. However, filtering is implied in the spectral mask, as seen in Figure 2.3.7. The $\text{sin}(x)/x$ plot shown with the spectral mask seems to indicate that the transmit filter approximates a RECT function, but that additional filtering is used to limit the sidelobes.

Today, where most of the signal processing is done in DSP, many designers will probably opt to use a modified RECT baseband filter to control the sidelobe levels. For example, a $BT=0.5$ Gaussian filter would produce an acceptable spectrum. The alternative is to use RECT filtered signals (i.e. logic signals) to modulate a carrier and limit the bandwidth with an IF filter.

One problem with the 802.11b standard is that the spectrum mask shown is that of a continuous signal. To measure the spectrum, the transmitter must be modified to produce a continuous signal or some form of gated spectrum analysis must be performed on the burst signal. The problem with configuring a transmitter for continuous output is that the final result may not be representative of actual performance under burst conditions.

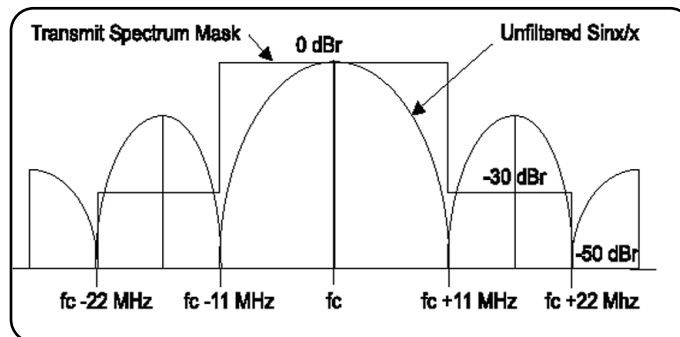

Figure 2.3.7: 802.11b transmit spectral mask

Many RF spectrum analyzers have a feature known as gated sweep. The purpose of gating, in all its various forms, is to measure the signal only when it is present. With swept analyzers, gated measurements can be somewhat difficult to set up. Most analyzers require a separate gate signal to tell the analyzer when to measure. Also, the time waveform cannot be observed during the gated spectrum measurement to ensure the gate is properly aligned.

In the Agilent 89640A VSA, spectrums are computed using FFT's instead of using swept LO's, mixers and power detectors. This approach has many advantages, especially when it comes to troubleshooting. Measurement setup is greatly simplified because the Agilent 89640A VSA can display the burst signal and the gate alignment while checking for spectral mask compliance.

The one problem with the FFT approach is that the FFT bandwidth is not wide enough for measuring the entire spectral mask in a single measurement. However, by adjusting the analyzer's center frequency, the measurement can be performed in two steps. In Figure 2.3.8, the lower half of the spectral mask is shown (hand drawn) on the spectrum plot. Of slight interest is the spur at an 11 MHz offset from the carrier. For strict adherence to the standard, a swept spectrum analyzer should be used.

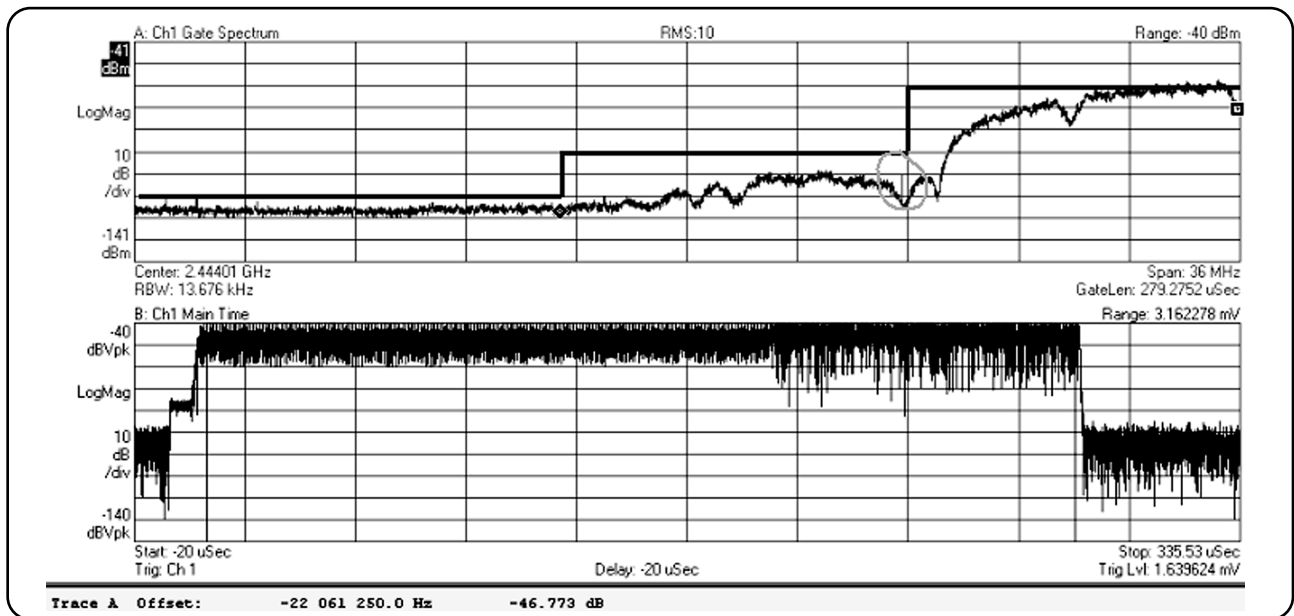

Figure 2.3.8: Signal analysis through gated sweep measurements

This spectrogram display in Figure 2.3.9 is comprised of hundreds of spectrum measurements taken over a single burst. Each spectrum measurement is flattened to one row of pixels. Since height can no longer be used to represent amplitude, color or shade depth is used instead.

The spectrogram display is useful for looking at the time-varying spectral characteristics of a burst. For example, the previous figure showed that the transmitter turned off quickly. This plot shows that the transient is not causing significant problems. If it had, there would be a widening of the spectrum at the bottom of the spectrogram.

Spectrogram displays have several attributes:

- Darker shades represent a high signal level, lighter shades represent a low level.
- The (horizontal) frequency axis is the same as for a regular spectrum display. The vertical axis is time instead of amplitude. The top of the spectrogram trace is the start of the burst and the bottom is the end of the burst.
- A special spectrogram marker, indicated by the horizontal line, was used to select one spectrum measurement for viewing. This spectrum is shown in the top portion of the lower trace.
- The spectrogram indicates that more energy is present at higher frequencies during the BPSK portion of the signal than during the QPSK version. This could possibly be due to cross-over distortion. The power envelope of the burst signal is shown for reference in the bottom of the lower grid.

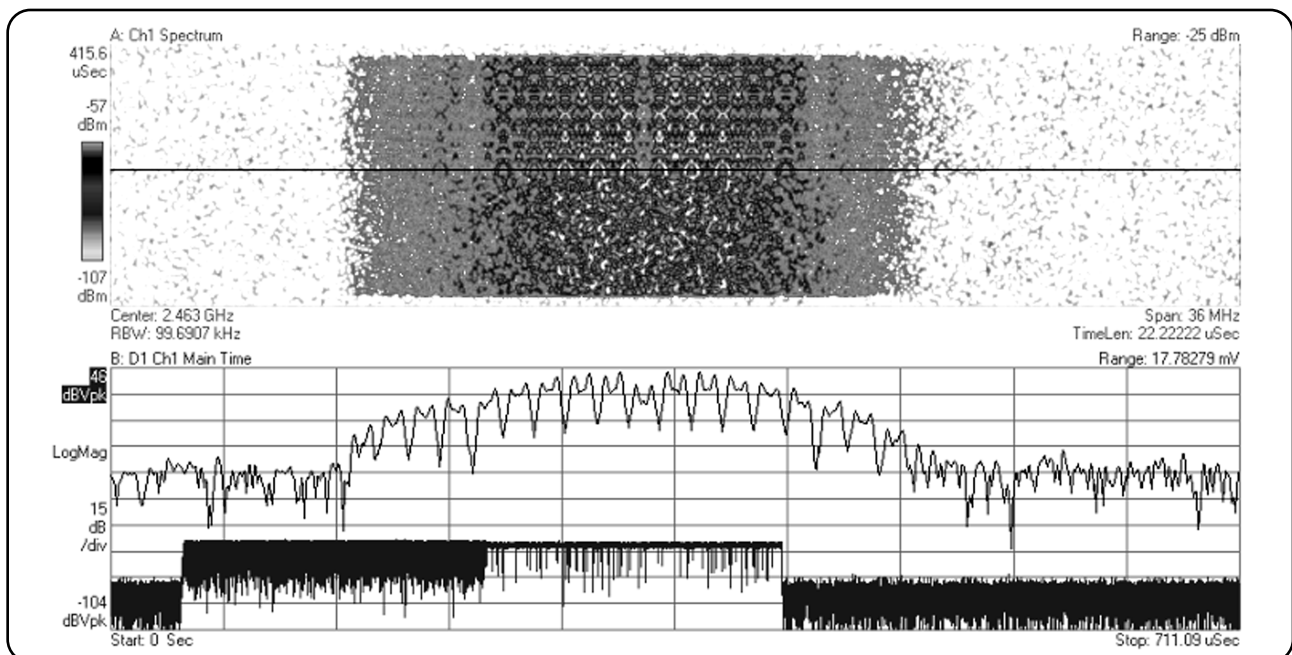

Figure 2.3.9: Spectrogram analysis of a single 802.11b burst

Often in the R&D phase of a project, the problem is not so much with the physical layer as it is with the MAC layer. While the Agilent 89640A VSA does not directly perform MAC layer testing, it can be used to gain insight into what's going on. One of the most powerful features of the analyzer is its optional 768 Msample deep-capture memory. This memory can be used to capture the signals up to 36 MHz wide without loss of information. At 36 MHz, 768 Msamples equates to 8 sec of continuous, gap-free data. With the span set to 18 MHz, the memory lasts for 16 sec. With the standard 12.7 Msample capture memory, the length would be 132 msec at 36 MHz.

Much can be learned simply by looking at the time waveform, as shown in Figure 2.3.10. Here, both PCMCIA and access point (AP) signals are visible. The last part of each burst in the figure reveals that the AP is using a QPSK modulation, whereas the PCMCIA card is staying at BPSK. One burst is significantly longer than the other, and the various timing relationships between the two transmitters can easily be determined.

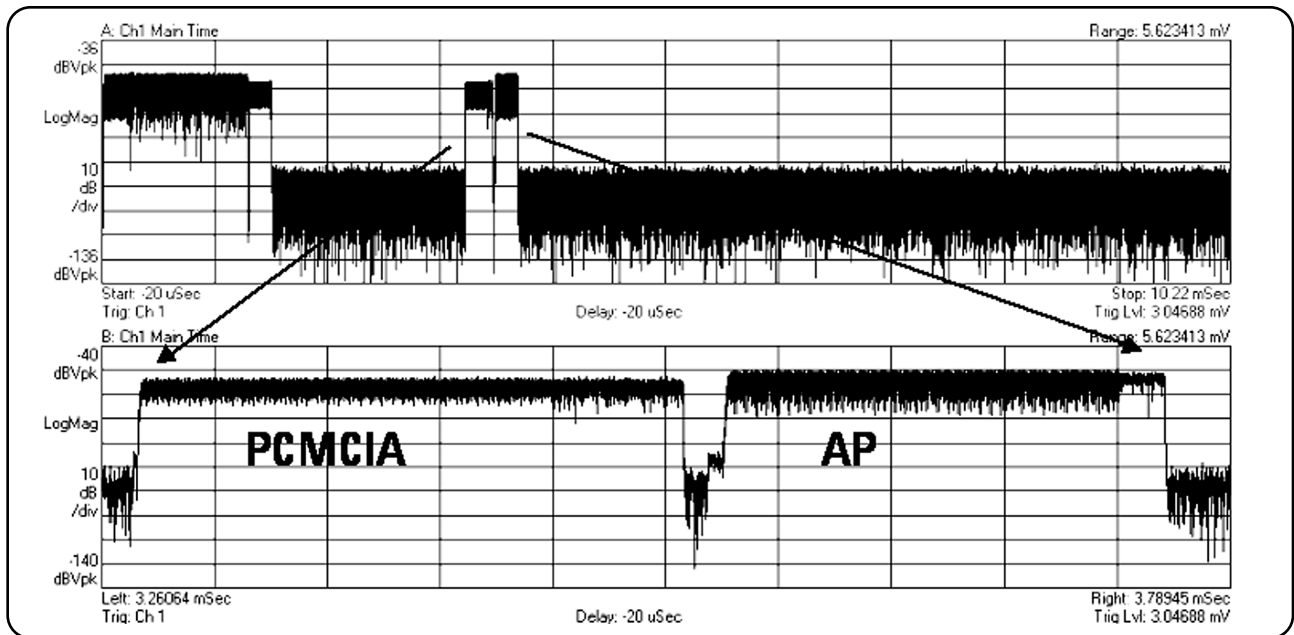

Figure 2.3.10: Analysis of an exchange between two WLAN modems

Once the signal has been captured in the analyzer's memory, it can be analyzed using a variety of tools. One of the most useful tools is modulation analysis.

As mentioned earlier, the preamble/header is BPSK modulated at 1 Mbit/sec. Relative to the QPSK modulation of the payload data, the BPSK modulation occupies two of the four corners of a QPSK vector diagram (Figure 2.3.11). The demodulation started before the amplifier was up to full power, as can be seen in the lower left trace, and in the constellation "spiral" in the center of the constellation. The upper right trace shows the phase error created by instability in the LO as the signal is turned on. Keep in mind that this is not a hopping signal.

The sync-search capability of the analyzer was used to highlight one symbol, 11 chips, or in this case 22 bits (due to the use of the 2-bit/sym generic QPSK demodulator). The single marker is at the same point in time in all four traces, and it is also one symbol back from the highlighted symbol. This measurement can verify that the Barker sequence has been correctly coded in the baseband processing. Because of the inherent coding gain in DSSS, a single chip error in this sequence would not break the radio; it would just degrade the performance.

In the summary table are measurements of EVM, magnitude error, phase error, frequency error/offset and carrier leakage. Remember the -34 dB value for leakage that was estimated using gated spectrum measurements in Figure 2.3.4? Here, the value was more accurately estimated at -36 dB. The greater accuracy comes in part from the measurement algorithms, but mostly because the value was estimated over 1.4 msec, instead of over just a few microseconds.

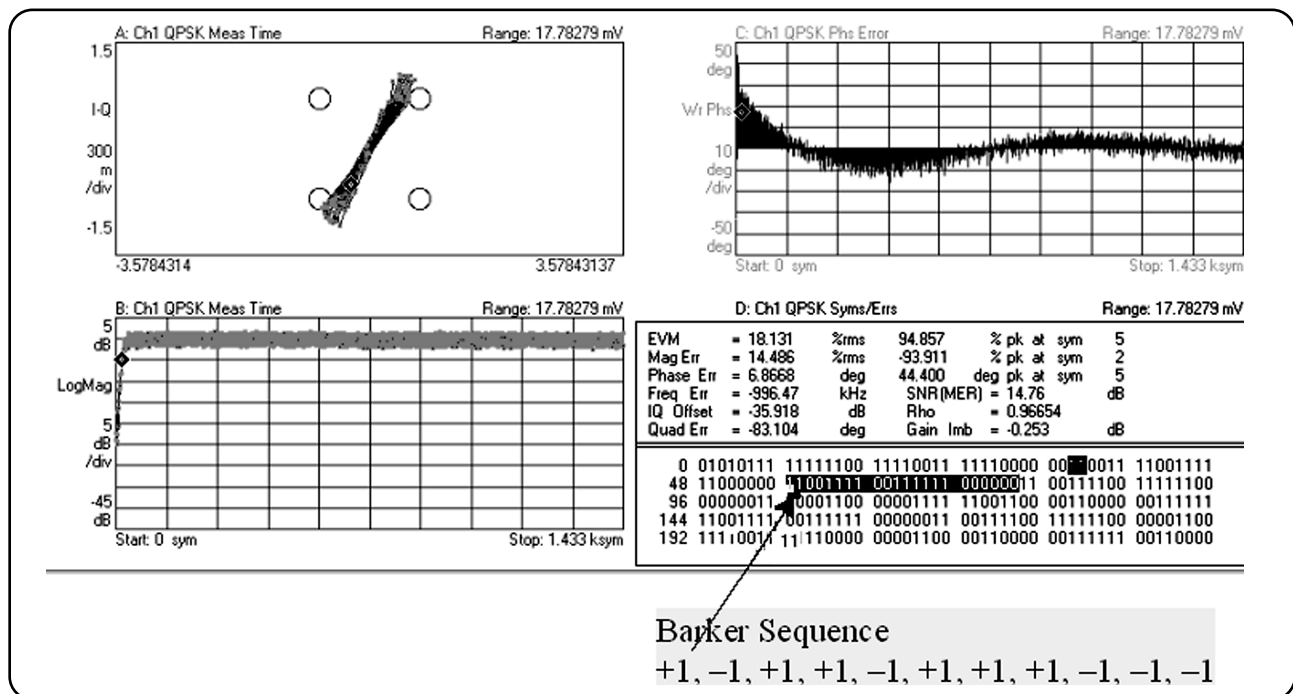

Figure 2.3.11: Demodulation of an 802.11b preamble

The 802.11b standard uses a metric called "Error Vector Magnitude" (EVM) as a measure of modulation quality. The basic signal error model is given in Figure 2.3.12. This metric has become an industry standard for a wide variety of applications from cellular phones to cable television. The basic idea behind EVM is that any impaired signal (usually complex signals) can be represented as the sum of an ideal signal and an error signal. Since the error signal cannot be measured directly, the test instrumentation reconstructs the ideal signal based on the detected data and subtracts it from the actual signal to determine the error signal.

The error signal includes all of the following sources of error:

- Additive noise
- Nonlinear distortion
- Linear distortion (equalized in 802.11a)
- Phase noise
- Spurious signals
- Other modulation errors

At any single point in time, the error signal can be represented as a complex vector reaching from the ideal point in the I/Q plane, to actual location. Every chip has its own error vector. EVM is simply the RMS over 1000 chips.

The ideal vector represents the theoretical instantaneous magnitude and phase of the carrier based on the known data stream. The actual signal is modeled as the summation of the ideal signal and an error signal, as shown in Figure 2.3.13. All signals are *complex*.

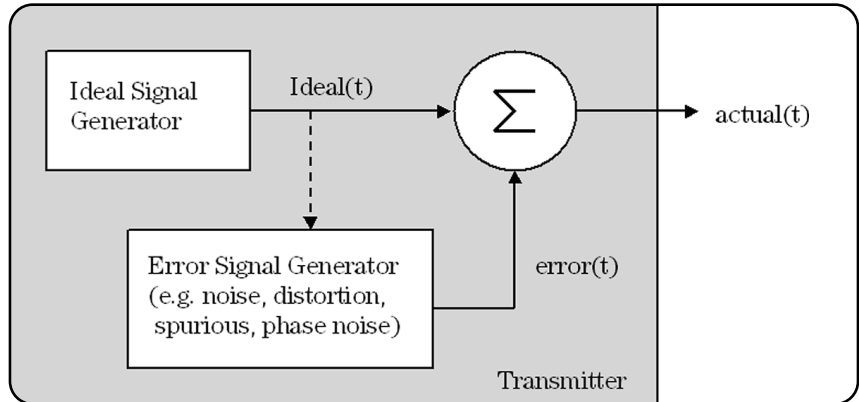

Figure 2.3.12: Signal error model

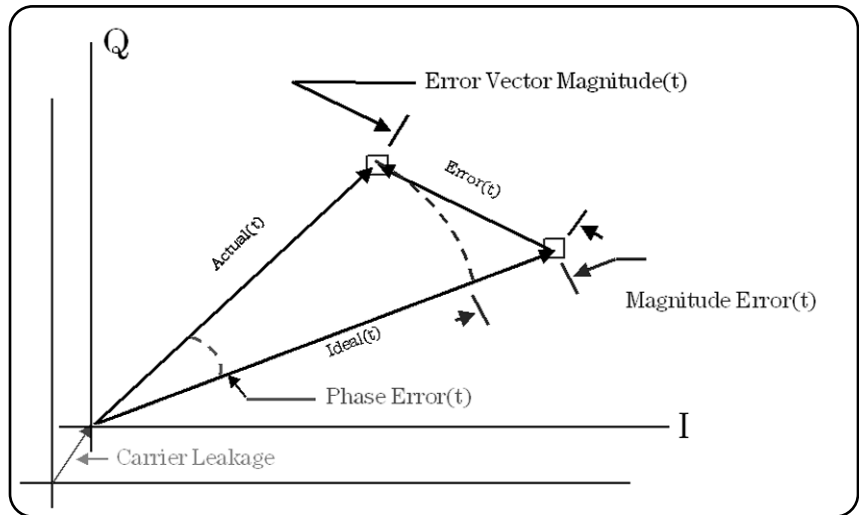

Figure 2.3.13: Error Vector Magnitude (EVM)

It is worth pointing out that the Agilent 89640A VSA does not compute EVM exactly as described in the 802.11b standard. As described previously, there is an attempt to properly scale the measured data and to remove carrier leakage terms before computing EVM. Most radio standards require that EVM be computed after carrier frequency, carrier phase, carrier leakage, and gain terms have been chosen to minimize EVM. These parameters

are not orthogonal, and therefore must be simultaneously estimated, or at least iterated, for minimum EVM. The EVM specification of 802.11b is a very generous 35%, which would be unusual for a QPSK signal, but is reasonable for DSSS. It is interesting to note that in 802.11b there is a separate measurement for carrier leakage. They do not use the dc I channel and the dc Q channel values computed as part of the EVM metric.

The Agilent 89640A VSA's QPSK demodulator has an adaptive equalizer that can be used for two purposes. First, it can be used to compensate for linear distortion so that non-linear distortion and spurious errors can easily be identified and quantified. Second, it can be used to determine multipath characteristics (to the degree possible using blind equalization).

The 802.11b specification does not allow for equalization prior to computing EVM. This means that any linear distortion, such as group delay distortion in the IF, will increase EVM. When EVM is high the equalizer can be used as a diagnostic tool. If use of the equalizer significantly improves the EVM result, then the channel frequency response should be

checked for flatness problems (i.e. group delay distortion). If it does not, then the problem is more likely related to noise, non-linear distortion, or spurious error.

The measurement shown in Figure 2.3.14 was made with an AP located about eight feet (non line-of-site) from an antenna connected to the Agilent 89640A VSA. The lower left plot shows the constellation without equalization. The upper right plot is the estimate of the channel response computed from the equalizer coefficients, which are shown in the lower right plot. The EQ coefficients give an indication of the delay spread in the signal.

When the equalizer is active, metrics such as EVM (not shown) reflect the errors in the post-equalized signal.

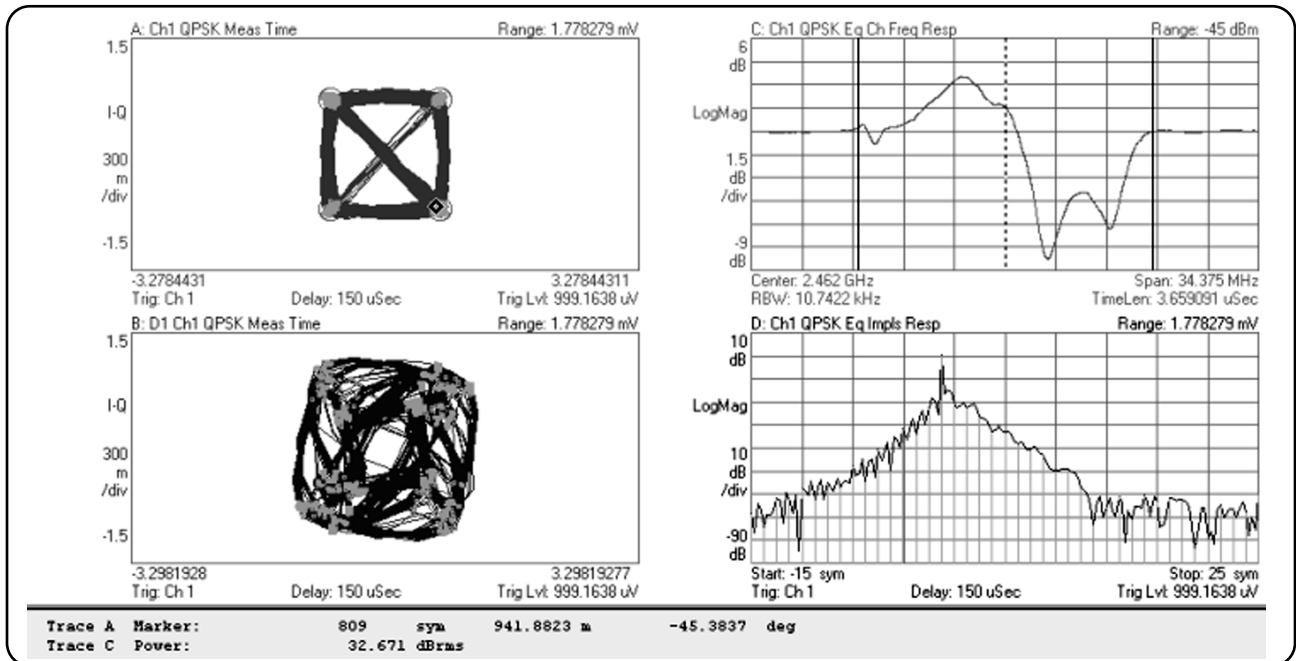

Figure 2.3.14: Effects of equalization on signal demodulation

3. 802.11a and HIPERLAN Type 2

3.1 OFDM signals

The 802.11a and HIPERLAN Type 2 standards use a modulation technology known as Orthogonal Frequency Division Multiplexing (OFDM). It was originally used in consumer products in Digital Audio and Digital Video Broadcasting and ADSL modems. It is now finding its way into broadband Internet access systems such as wireless LANs and Point-to-Multipoint distribution systems.

The concepts behind OFDM have been around for a long time. However, it has only been within the last few years that the baseband processing has been inexpensive enough to allow for practical implementations. OFDM was first proposed as a way of dealing with multipath. One of the problems with single carrier modulations (SCM) is that, in a given environment, as the symbol rate is increased, the symbol interval becomes shorter than the delay spread. Multi-carrier modulation formats solve this problem by decreasing the symbol rate and increasing the number of carriers. The basic idea is to take a signal and send it over multiple low-rate carriers instead of a single high-rate carrier to eliminate inter-symbol interference (ISI) and then compensate for multipath effects with a simple equalizer. OFDM is a very flexible modulation format in that it can be easily scaled to meet the needs of a particular application. For applications like VOFDM, the lack of ISI also greatly simplifies the implementation of diversity reception.

The 802.11a and HIPERLAN Type 2 standards are almost identical in terms of the physical layer. The remainder of this application note will concentrate on 802.11a, recognizing that the measurement concepts are applicable to both standards.

The RF portion of the 802.11b signal, while challenging to make small and inexpensive, is not very challenging in terms of bits/Hz. There is a sizable error margin built into the format. The CCK format has a low peak-to-average ratio, making it easy to amplify, and the complementary codes have some immunity to phase rotations caused by phase noise. The EVM specification of 35% should be easy to maintain in a high-volume production line.

The 802.11a format is more challenging, as the raw data rates are increased up to 5 times, without increasing the bandwidth. The challenges extend from the basic problems associated with going to 5 GHz, to the difficulties of designing stable LO's and efficient amplifiers for the high peak-to-average, multi-carrier OFDM signals. The challenges will not be limited to design. The products will also be more difficult to integrate and manufacture.

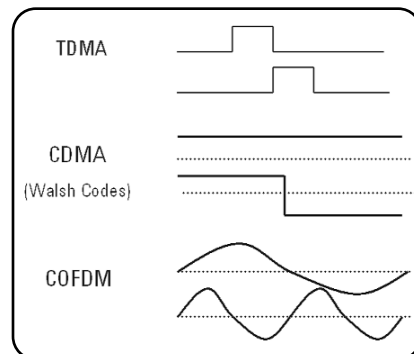

Figure 3.1.1: Orthogonal signals

Two signals are orthogonal in a given interval if, when multiplied together and then integrated over that interval, the result is zero. TDMA is not normally considered an orthogonal coding scheme. However, the idea applies if the time interval is considered to be the burst width. Over that interval, the other signal is zero, so the dot product of the two is zero.

Walsh codes, which are used in CDMA systems, are orthogonal, and are probably the most common form of orthogonal signaling. For example in IS-95, length 64 Walsh codes provide 64 possible code channels.

OFDM is actually very closely related to CDMA. Instead of Walsh codes, the basis functions are sinusoids. In a given period, the sinusoids will be orthogonal provided there are an integral number of cycles. The amplitude and phase of the sinusoid, which will be used to represent symbols, does not affect the orthogonality property. Using sinusoids instead of Walsh codes produces a spectrum in which it is possible to associate a carrier frequency with a code channel.

In traditional frequency division multiplexing systems, the channel spacing is typically greater than the symbol rate. This is done in order to avoid overlapped spectrums. In OFDM, the carriers are orthogonal and overlap without interfering with one another. The idea is similar to that of Nyquist filtered SCM signals. The symbols in a single-carrier system overlap in the time domain, but do not interfere with one another because of the symbol (T) spacing of the zero crossings. For OFDM, the carriers have a spectral null at all other carrier frequencies.

Non-linear distortion and phase noise are the two largest contributing factors to a loss of orthogonality, creating inter-carrier interference. Poor frequency estimation in the receiver is another contributing factor.

Some advantages of OFDM:

- Increased efficiency due to reduced carrier spacing (orthogonal carriers overlap).
- Equalization is simplified, or eliminated.
- Greater resistance to fading.
- Data transfer rate can be scaled to conditions.
- Single Frequency Networks are possible (broadcast application).
- Available because of advances in signal processing horsepower.

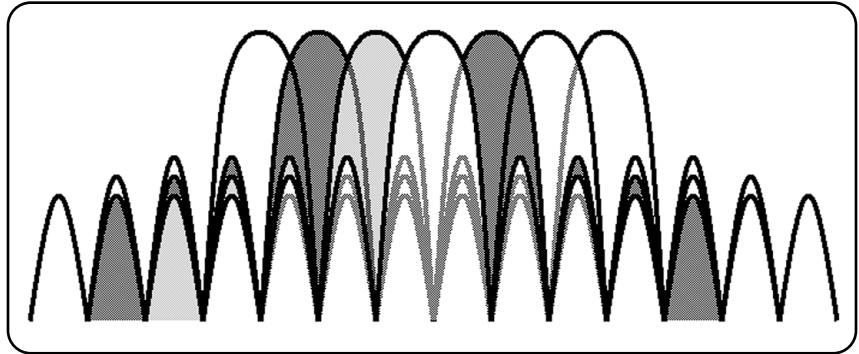

Figure 3.1.2: OFDM carrier separation

Some disadvantages of OFDM:

- A higher peak-to-average ratio.
- Increased sensitivity to phase noise, timing and frequency offsets.
- Greater complexity.
- More expensive transmitters and receivers.
- Efficiency gains reduced by requirement for guard interval.

The two biggest RF problems with OFDM are amplification, due to the higher crest factor, and frequency accuracy and stability (phase noise). The amount of additional power amplifier (PA) backoff, or headroom, required for OFDM is hotly contested. Some OFDM proponents believe that only 1 to 2 dB are required over single carrier modulations.

Others believe that the number is much higher. As with most requirements, it really depends on the assumptions. The amount of backoff is a strong function of adjacent channel considerations, and to a lesser degree it is a function of in-channel distortion.

The carrier orthogonality is a strong function of the frequency accuracy of the receiver and the phase-noise performance of both TX and RX. Tighter phase noise requirements and linear PA's contribute to greater implementation costs.

In 802.11a, the data carriers can be BPSK, QPSK, 16 QAM, or 64 QAM modulated. In 802.11a, only two modulation formats are used simultaneously – BPSK and one of the previously mentioned formats. It is interesting to note that the center carrier is not used in either Digital Audio Broadcast (DAB) or WLAN applications. Removing the carrier slightly reduces the data capacity, but allows the requirements on carrier leakage to be relaxed. Table 3.1.1 provides a summary of the different modulation formats used in OFDM systems and their associated rate-dependent parameters.

Data rate (Mbits/s)	Modulation	Coding rate (R)	Coded bits per subcarrier (N_{BPSK})	Coded bits per OFDM symbol (N_{CBPS})	Data bits per OFDM symbol (N_{DBPS})
6	BPSK	1/2	1	48	24
9	BPSK	3/4	1	48	36
12	QPSK	1/2	2	96	48
18	QPSK	3/4	2	96	72
24	16-QAM	1/2	4	192	96
36	16-QAM	3/4	4	192	144
48	64-QAM	2/3	6	288	192
54	64-QAM	3/4	6	288	216

Table 3.1.1: Rate-dependent parameters

The 802.11a and 802.11b signals occupy about the same bandwidth. Each has its own spectral mask to be measured against. As before, the standard specification describes this measurement using a standard swept-spectrum analyzer. If a special test mode is not available to output a continuous signal, then gated spectrum analysis must be used.

The OFDM spectrum is very flat across the top. As drawn in the standard, the sidelobes could be mistaken to be third-order distortion. In fact, the sidelobe structure of this signal is part of the modulation.

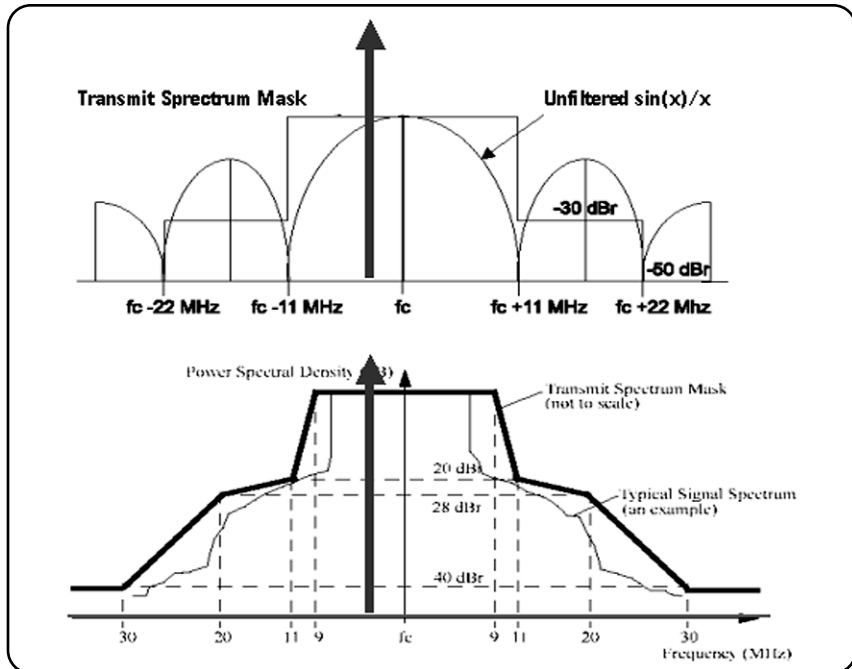

Figure 3.1.3: Transmit spectrum mask for 802.11a

One of the problems with single carrier modulations is, in a given environment, the symbol interval becomes shorter than the delay spread as the symbol rate is increased. Multi-carrier modulation formats solve this problem by distributing the data across multiple lower symbol rate

carriers. The symbol interval for each of the lower-rate carriers is made longer compared to the delay spread. To increase robustness, should a subset of the carriers be unusable because of nulls or interference, the information is interleaved

between carriers. The interfering tone shown in Figure 3.1.3 would do little damage to the OFDM signal.

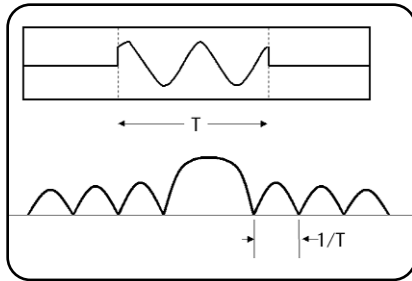

Figure 3.1.4: Spectral shape of a signal OFDM carrier

Figure 3.1.4 shows the real reason for the OFDM spectral characteristics shown in Figures 3.1.2 and 3.1.3. For a single carrier, one can model the transmitted pulse in the time domain as a sinusoid multiplied by a RECT function. In the frequency domain, this is simply a $\sin(x)/x$ shape convolved with an impulse at the carrier frequency.

The $\sin(x)/x$ spectrum has nulls at adjacent carrier frequencies, provided that the sinusoid is on frequency and has zero bandwidth, and the RECT function is the proper width. The RECT function can have the wrong width if the ADC/DAC sample rates are incorrect, in either the transmitter or receiver. The zero-width assumption can be violated by phase noise in either the transmitter or the receiver.

The OFDM signal is comprised of 52 carriers. The carriers at the extreme frequencies are the ones that contribute most to the sidelobe structure shown in the spectral mask plot shown in Figure 3.1.3.

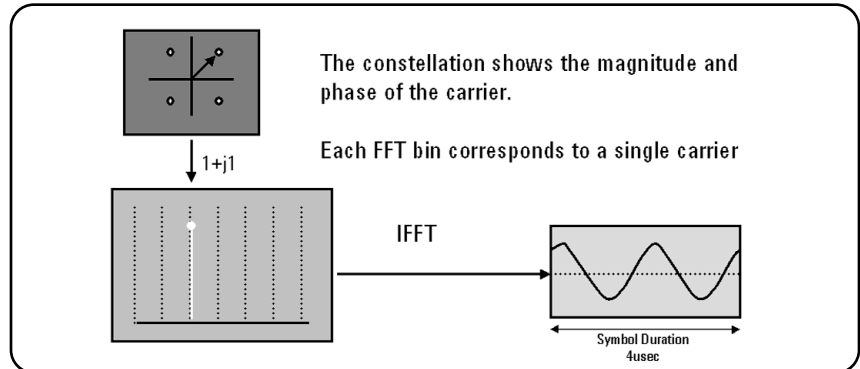

Figure 3.1.5: IFFT used to create one carrier

Basic knowledge about FFT's should make the concepts behind OFDM simple to understand. In Figure 3.1.5, an OFDM signal with only one carrier is created. The magnitude and phase of the carrier are determined from the symbol to be transmitted, as shown in the constellation diagram. The complex number representing the symbol is loaded into an FFT buffer, and an inverse-FFT (IFFT) is performed. This produces a set of time-domain samples, which are then transmitted. In 802.11a and HIPERLAN Type 2 the FFT size is 64, with 52 of the FFT bins loaded with data and pilots. After the IFFT, all 64 time samples are transmitted.

While the first pulse is being transmitted, the next symbol is loaded into the FFT buffer. Notice that the second pulse (Figure 3.1.6), when joined with the first, results in a discontinuity. This is normal. The resulting spectral splatter can be attenuated somewhat by windowing the data, as described in the 802.11a standard.

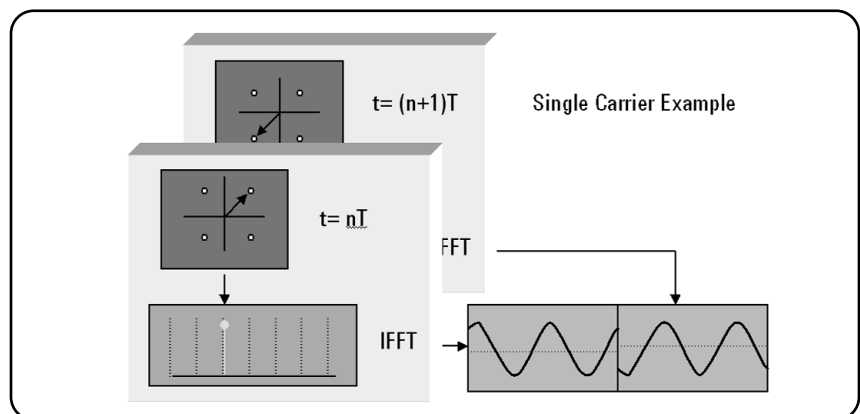

Figure 3.1.6: One IFFT per symbol period

Figure 3.1.7 shows how a multi-carrier OFDM signal is generated, and how easy it is to have many different modulation formats. As more carriers are added, the resulting time waveform becomes more complex. This is one of the problems with OFDM. Described later, the addition of multiple carriers results in a signal with a high peak-to-average power ratio.

There are many ways to consider the orthogonality properties in OFDM. In terms of FFT's, a signal that is perfectly periodic in the FFT time record has nulls in adjacent FFT bins.

The reason that OFDM is more sensitive to phase noise should now be obvious. The phase noise is an additional modulation that will modify the $\sin(x)/x$ spectrum, reducing the depth of the nulls, and creating interference to other carriers (not shown).

Receiver frequency tracking is critical. (Figure 3.1.9) If the receiver is off frequency, then the nulls in each carrier will not land on a FFT bin. In FFT terminology, this is called leakage. For OFDM, the result is inter-carrier interference (ICI).

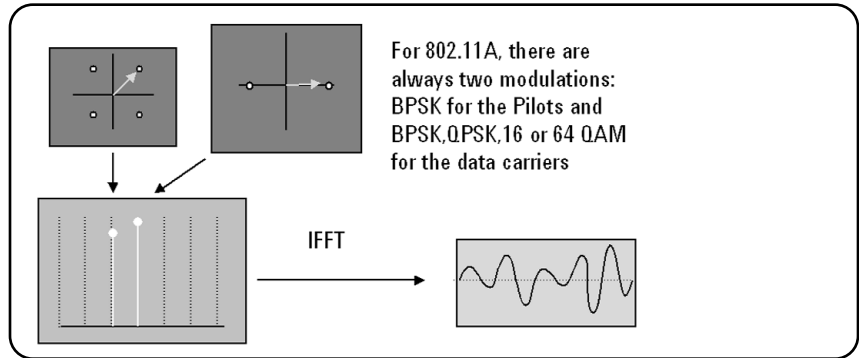

Figure 3.1.7: IFFT used to create multiple carriers

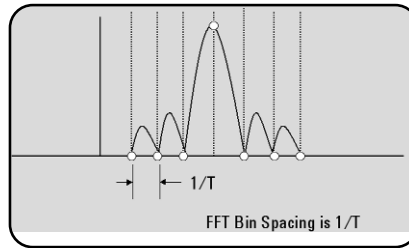

Figure 3.1.8: For FFT, nulls are "on bin" if the tone is on bin

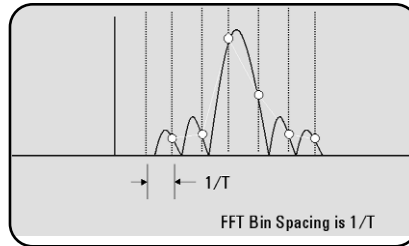

Figure 3.1.9: Leakage effects of frequency errors and phase noise

3.2 Dealing with multipath

The processing of a received OFDM signal is illustrated in Figure 3.2.1. The waveform is digitized and converted back to a symbol using a FFT. T_u refers to the meaningful part of the waveform.

The simple OFDM signal generated in the example will not work under multipath conditions. As shown in Figure 3.2.2, if the FFT is aligned with the biggest signal, then the other signal paths will introduce ISI.

In the example shown earlier in Figure 3.1.6, the effects of the channel were ignored, and two pulses from subsequent symbols were spliced together. This will not work in practice because the channel will still introduce ISI between pulses. To combat the problem, the pulse is modified by a technique known as *cyclic extension* (see Figure 3.2.3). In this process, the last 1/4 of the pulse is copied and attached to the beginning of the burst. This is called the guard interval (T_g). Due to the periodic nature of the FFT, the junction between the guard interval waveform and the start of the original burst will always be continuous. However, the waveform will still suffer from discontinuities at the junctions between adjacent symbols.

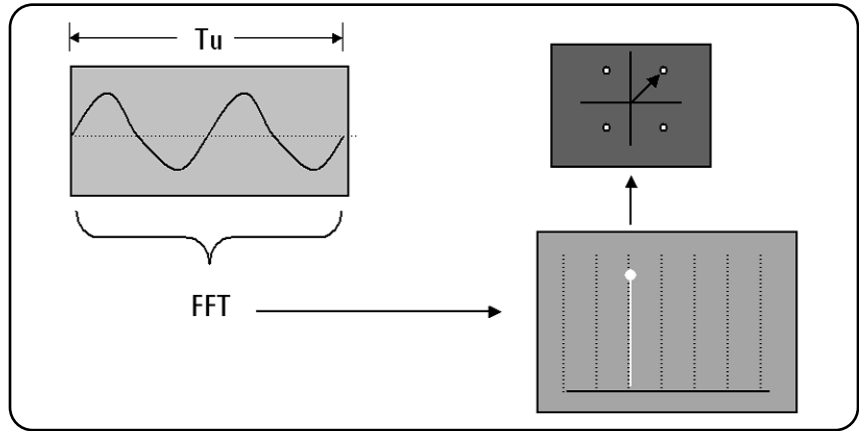

Figure 3.2.1: Receiving an OFDM signal

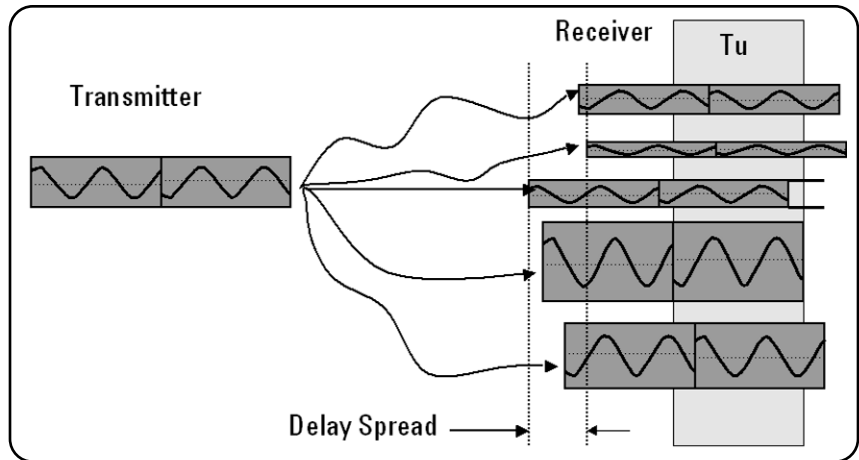

Figure 3.2.2: Effects of multipath delay

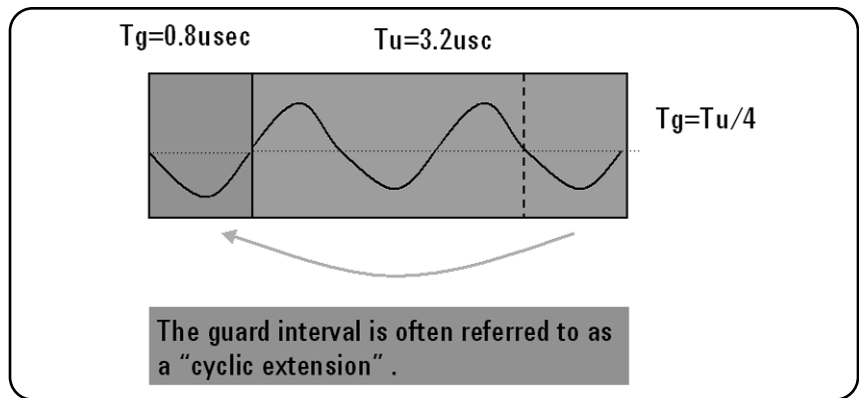

Figure 3.2.3: Cyclic extension

Figure 3.2.4 illustrates how the addition of a guard interval helps with ISI. Shown are two copies of the same signal. Each copy takes a different path so they arrive at the receiver at slightly different times, where they are combined in the receiver's antenna into a single signal. In the time interval denoted by the box marked T_u , the signal will only interfere with itself. This amounts to a scaling and rotation of the symbol, nothing more.

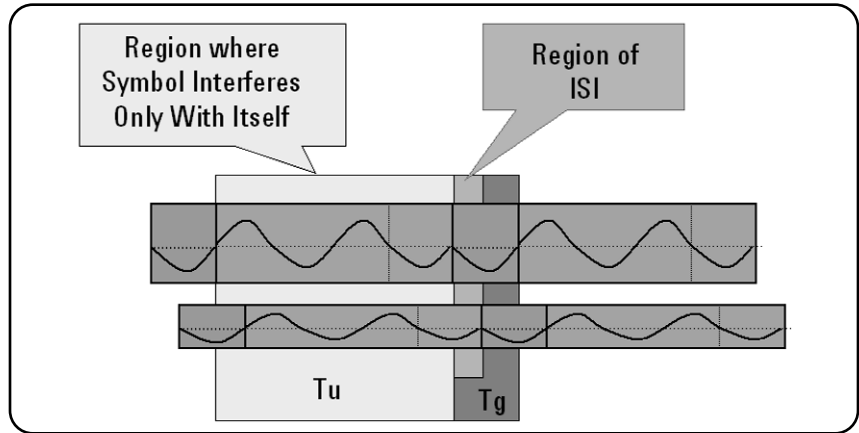

Figure 3.2.4: Guard interval and signal interactions

In the guard interval region (T_g), it is easy to see that the resulting signal will have contributions from both symbols – ISI. The guard interval is ignored in the receiver, so that the ISI does not degrade receiver performance. Obviously the guard interval needs to be longer than the delay spread, but not so long that throughput is lost. In the 802.11a standard, the guard interval is fixed.

The windowing of data to reduce out-of-band power (Figure 3.2.5) involves multiplying the guard interval region by a shaping function, usually a raised cosine window function. The disadvantage of this technique is that the window interval intrudes into the next symbol's guard interval, thus reducing that symbol's resilience to interference from multipath delay.

Delay spread is not limited to positive delays. In non line-of-site conditions, the shortest path may not be the strongest. The implication on OFDM receivers is that the FFT may not be perfectly aligned with the useful part of the burst (as it is often called, since the guard band is simply discarded by the receiver). Instead, the receiver will shift the FFT location to the left, using part of the guard interval instead of only the entire portion of the useful part of the burst.

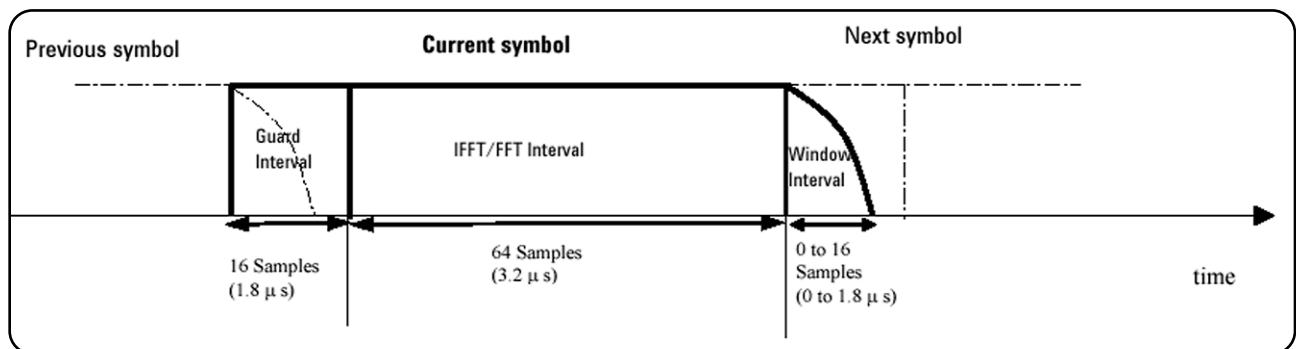

Figure 3.2.5: Windowing of OFDM symbols to reduce out-of-band power

3.3 Modulation analysis of an OFDM signal

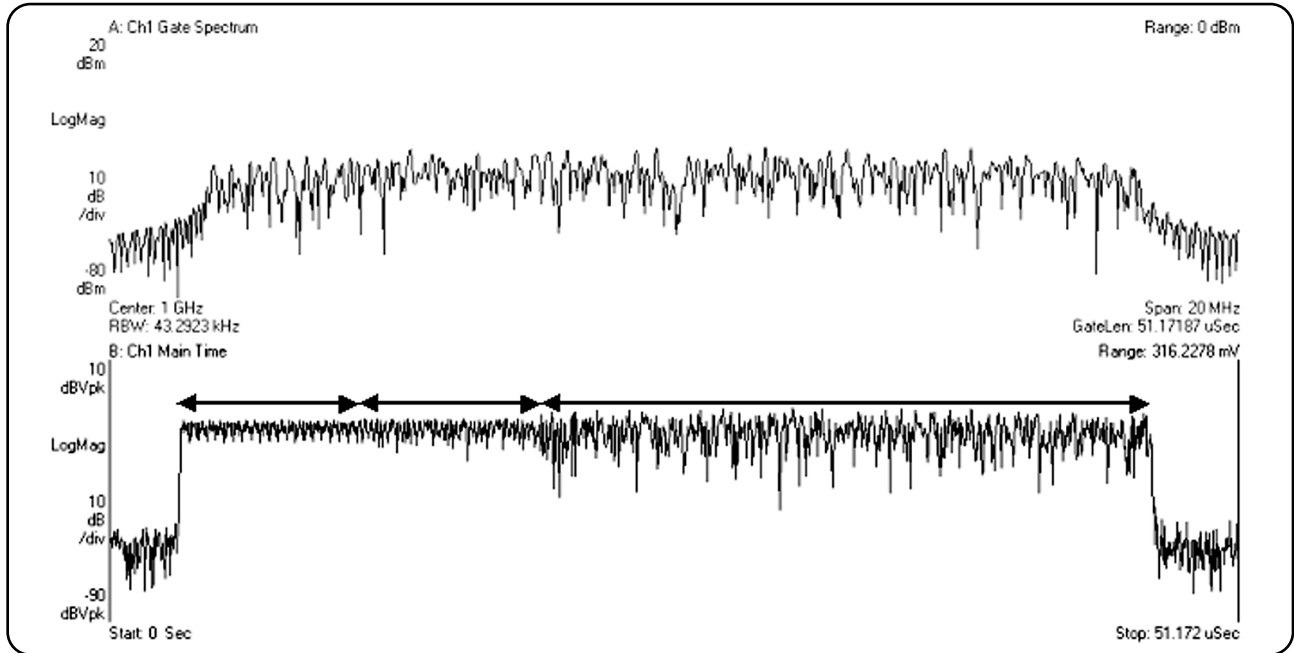

Figure 3.3.1: OFDM power burst and spectrum

Figure 3.3.1 shows an 802.11a burst. The sidelobe structure caused by the $\sin(x)/x$ spectrums of the individual carriers is clearly visible in the spectrum plot. Note that the spectrum is not very uniform. This is caused in part by the preambles, but mostly by the data being transmitted. In the power-versus-time plot in the lower trace, three distinct regions of the burst are visible.

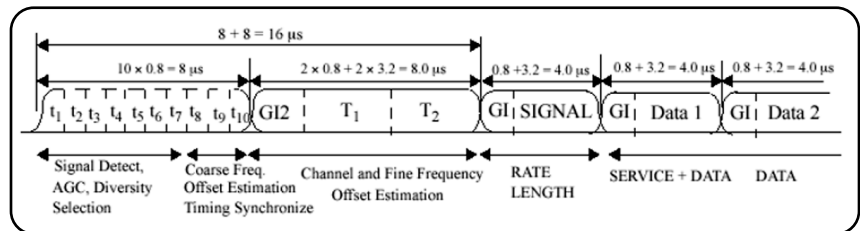

Figure 3.3.2: OFDM training structure

An OFDM burst actually has four distinct regions (Figure 3.3.2). The first is the *Short training sequence*, followed by a *Long training sequence* and finally by the *Signal and Data symbols*. From a RF standpoint, the Signal symbol and the rest of the OFDM symbols are similar.

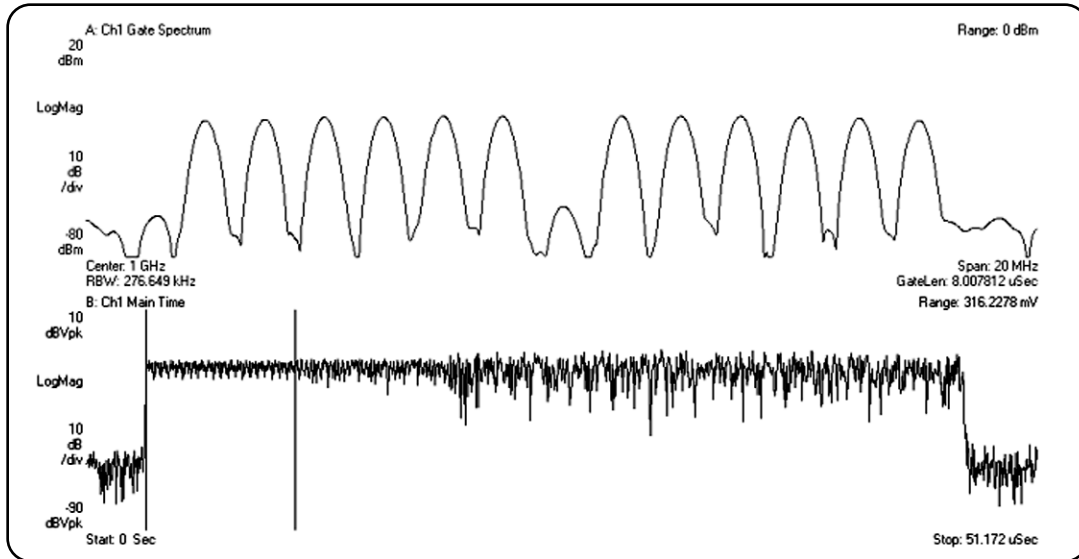

Figure 3.3.3: 802.11a short training symbol spectrum

The spectrum of the short training symbol can be seen (Figure 3.3.3) by using the gate markers. This symbol uses every 4th carrier, so the carriers are widely spaced. The center carrier is not used in 802.11a. The wide carrier spacing of the short training symbol makes this symbol interval ideal for easy carrier leakage measurements.

When the gate markers are moved over to the long training symbol, we can see that the spectrum is nice and flat (Figure 3.3.4). For this symbol, all of the carriers (save the one in the center, which is not used) have the same amplitude. The signal flatness is easily measured using the long training symbol interval.

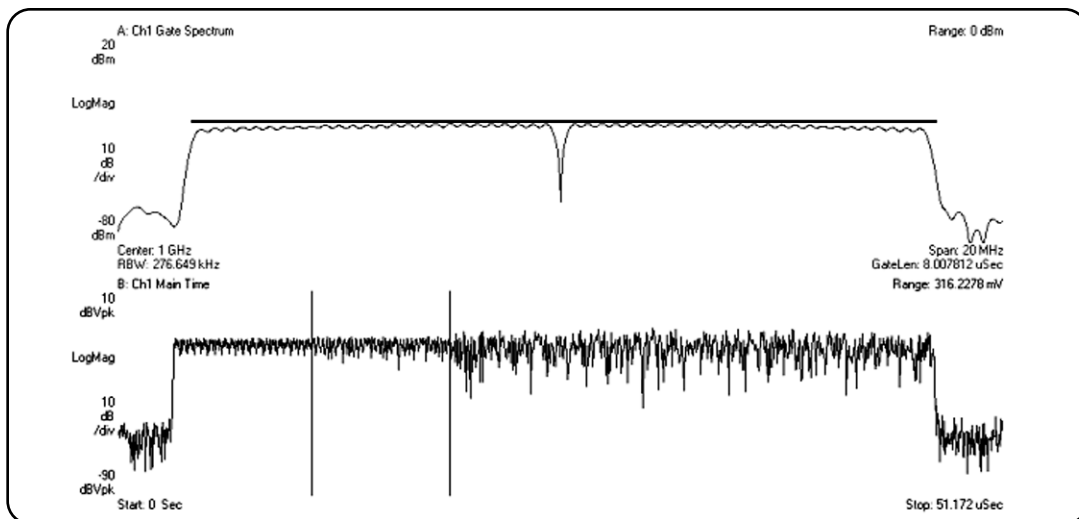

Figure 3.3.4: 802.11a long training symbol spectrum

It is useful to consider OFDM from a 2-dimensional standpoint. Figure 3.3.5 shows the short sequence, which uses every fourth carrier, followed by the long sequence, and finally by the data carriers. In 802.11a, four of the 52 carriers in the data portion of the burst are pilots, although only one is shown (darkly shaded column in the middle). The data carriers change in power level on a symbol-by-symbol basis when 16 or 64 QAM is used.

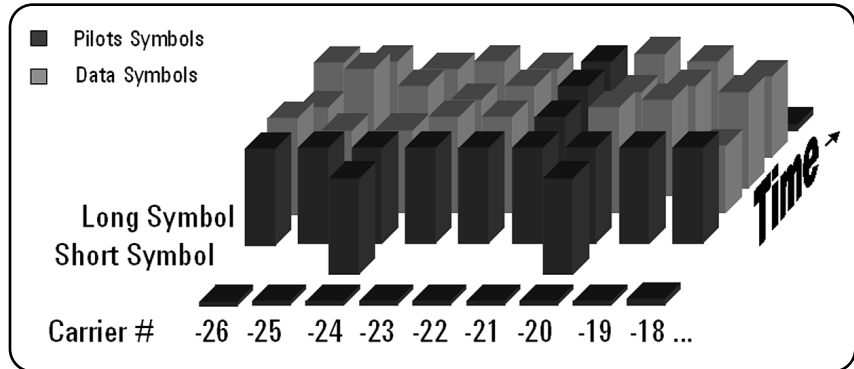

Figure 3.3.5: 802.11a carrier assignments.

The spectral characteristics of OFDM signals as a function of time can be observed using a spectrogram, shown in the top half of Figure 3.3.6. In the lower trace, the spectrum is shown at a point in time indicated by the horizontal line in the upper trace. The top of the upper trace corresponds to the beginning of the burst.

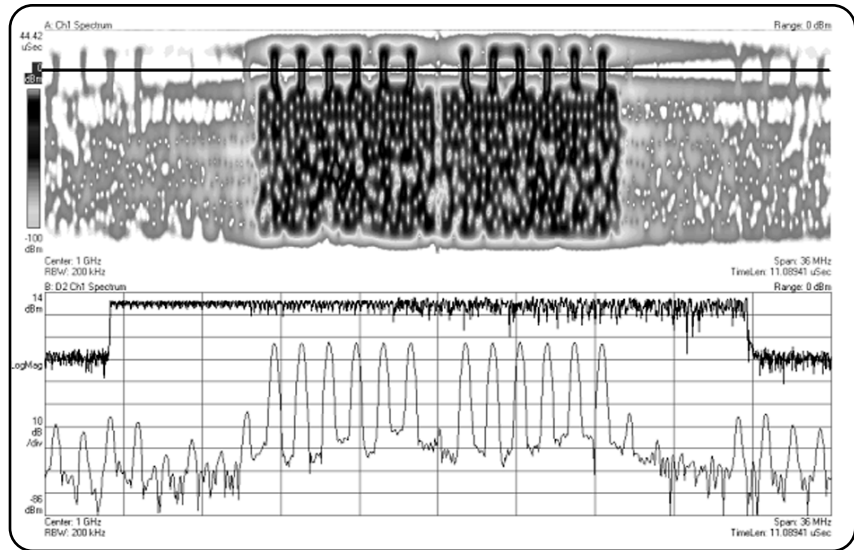

Figure 3.3.6: Spectrogram analysis of an OFDM burst

The short sequence, using every fourth carrier, is clearly visible, along with the discrete tones in the resulting sidebands. Also visible is the spectral splatter to the left and right of the signal caused by the discontinuities between symbols. The latter is most visible at the junction between the short and long syncs.

For reference, the power-versus-time plot is shown in the upper part of the lower grid.

Given the spectral splatter of this signal, it would be dangerous to model the effects on an adjacent channel by assuming Additive White Gaussian Noise (AWGN).

Figure 3.3.7 shows the 802.11a constellation for an entire burst. Note this constellation contains both the BPSK format always used in the training sequences, the signal symbol and on the pilot carriers, along with the format (16 QAM in this case) on the data carriers. The standard requires an adaptive equalizer, the lower left trace shows the phase response of the equalizer used for this burst. Viewing the complex equalizer result provides a measure of transmitter performance and/or the propagation path. The upper right trace shows the EVM of each carrier in the burst. Each column of dots shows the EVM of a carrier for each symbol in the burst. The dark line shows the average EVM across the carriers. The shape of this profile indicates problems such as gain imbalance and I/Q time mismatch. The table in the lower right gives some of the key metrics of this signal including overall EVM in dB, another requirement of the 802.11a specification.

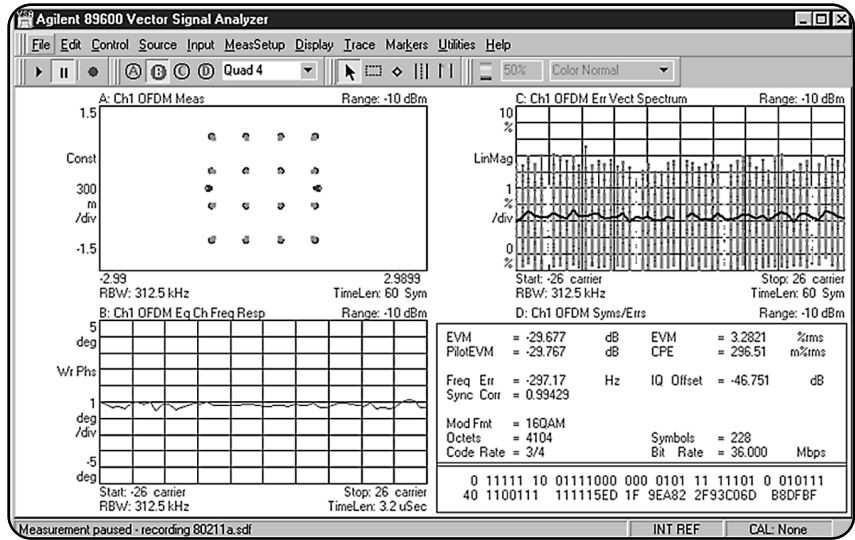

Figure 3.3.7: OFDM constellation and EVM plots

The power envelope of an OFDM burst is not constant. A single metric, peak-to-average ratio (PAR), is often used to describe the amount of headroom required in an amplifier. For OFDM signals, this metric is not very useful because the "real peak", whatever that is, may not occur very often.

It is more meaningful for OFDM signals to associate a percentage probability with a power level. As shown in the Figure 3.3.8, the signal exceeds the average power (dark horizontal line) 40% of the time. (It would be 50% only if the mean and median were identical). It exceeds a level that is 4 dB above the average, 5% of the time. In other words, if this particular signal were run through a PA with 4 dB of headroom, or back-off, the signal would clip 5% of the time. This is more useful than knowing that the peak-to-average for this signal is 8 dB.

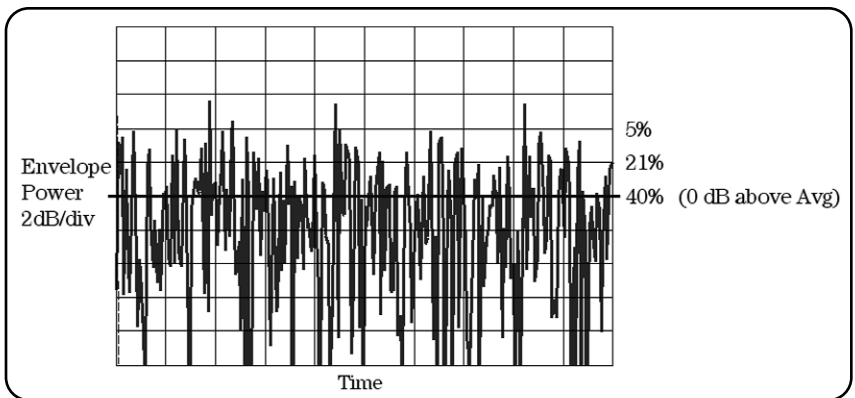

Figure 3.3.8: Power versus time for an OFDM burst

The best way to look at power statistics is using the complementary cumulative distribution function (CCDF). In the measurement shown in Figure 3.3.9, the gate markers are used to select the active portion of the burst. If this were not done, the periods when the burst is off would bias down the average power calculation.

The CCDF, which is simply the more common CDF subtracted from 1.0, shows dB above average power on the horizontal axis, and percent probability on vertical axis. The marker shows that, for this one burst, the signal exceeds 7.2 dB above average 0.09% of the time. Normally, the CCDF measurement would be made over several bursts to improve the confidence interval on the low probability peaks. The curved graticule line represents the statistics for Gaussian noise. Most OFDM signals will have statistics that follow that line very closely.

The EVM concept used for 802.11b is valid for 802.11a. For 802.11b, there is only one constellation, but for 802.11a the constellation will change depending on the data rate. Unlike QPSK, the OFDM constellations do not have all of the symbols at the same amplitude (distance from the origin).

The OFDM constellations are normalized to unity power. For this reason, the EVM computation does not need to be normalized – provided the transmitted data produces a uniform distribution of constellation points. A more rigorous approach to EVM computation would not assume a uniform distribution of transmitted symbols and would instead factor in the average power level of the ideal symbols actually transmitted.

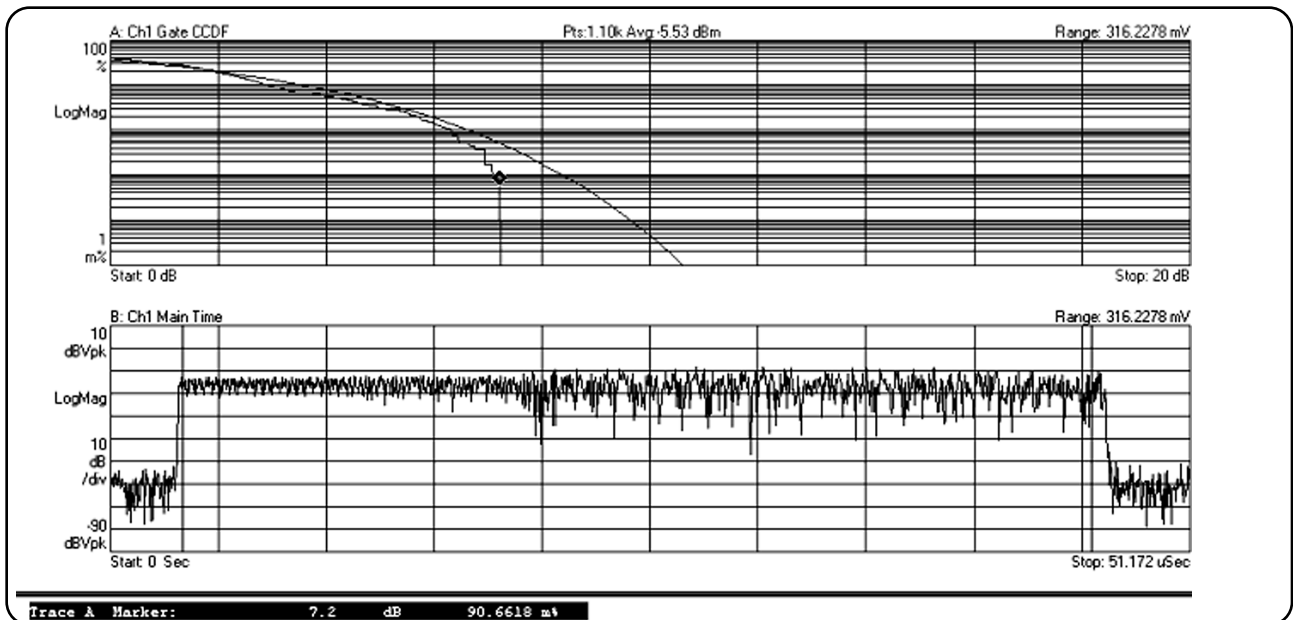

Figure 3.3.9: CCDF curve

Figure 3.3.10 shows an OFDM constellation in the upper trace. It is a composite plot of all carriers over all symbols. The constellation is a composite of the BPSK carriers and the 16 QAM carriers. Shown in the lower trace is the adaptive equalizer response. In 802.11a, the long training symbol is used to train an equalizer. This is a required step in the measurement process. The complex equalizer result can be viewed as magnitude, phase or group delay. The magnitude and phase responses are shown. The equalizer result is a good measure of transmitted flatness and carrier power levels.

The 802.11a standard establishes *Relative Constellation Errors* for each of the data rates. These are expressed in dB, while the error computation is defined in RMS units. The allowable EVM values in %RMS are shown in Table 3.3.1.

In 802.11a, data rates of 6, 12 and 24 Mbit/sec are mandatory for compliance with the standard, and utilization of the remaining data rates in the specification is optional. In a production environment, it should be necessary to measure the EVM only at the highest rate supported. Outside of slightly different power statistics, there are very few error inducing mechanisms that would cause a transmitter to have a significantly different measured EVM for each rate (given the

normalized constellations). The highest mandatory data rate is 24 Mbit/sec, for which an EVM of 15.8% is specified. 54 Mbit/sec modems will need to achieve 5.6% EVM. It may be that some companies plan on grading modems as they come off of the production line. Modems that achieve 5.6% EVM could be labeled as 54 Mbit/sec capable modems, while those that have worse performance could be sold as 24 Mbit/sec modems, instead of being scrapped.

Data Rate (Mbit/sec)	Relative Constellation Error (dB)	EVM (%RMS)
6	-5	56.2
9	-8	39.8
12	-10	31.6
18	-13	22.3
24	-16	15.8
36	-19	11.2
48	-22	7.9
54	-25	5.6

Table 3.3.1: 802.11a modulation quality and relative constellation error

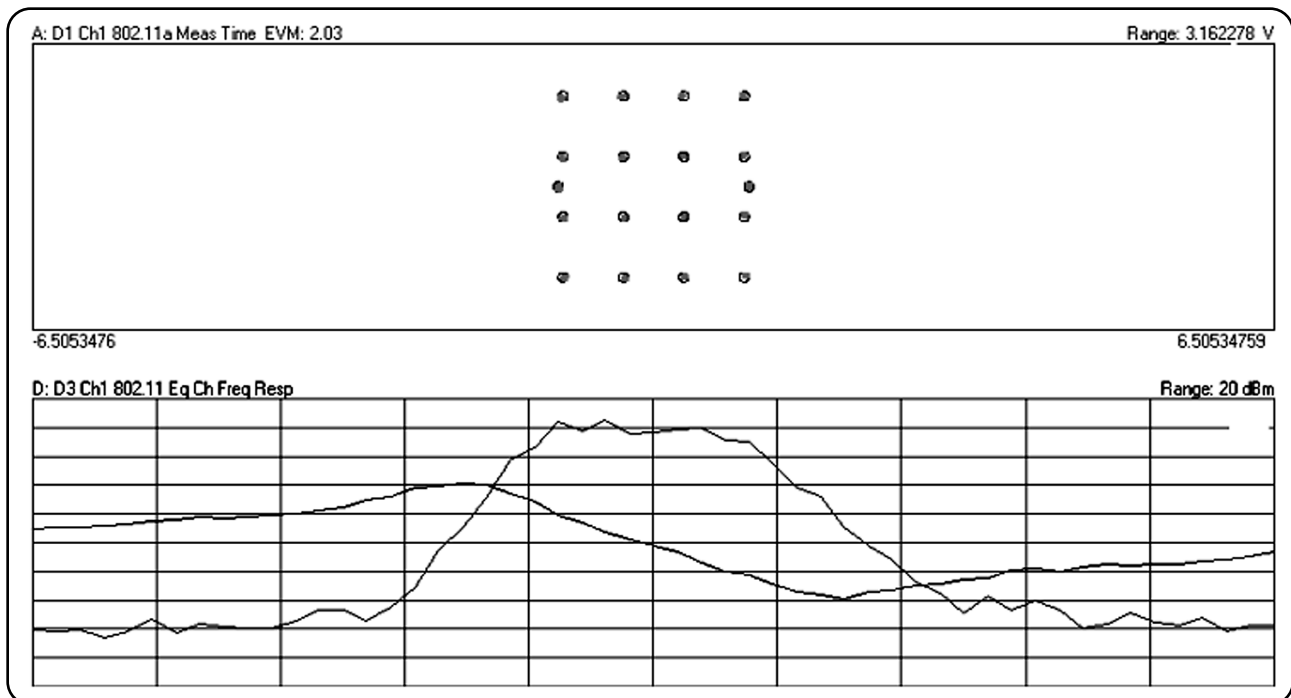

Figure 3.3.10: EVM for OFDM

4. Conclusion

This application note has examined the modulation technology and signal characteristics behind the major WLAN standards, and the relevant signal measurement and analysis techniques needed in order to evaluate RF performance. The principal focus of this document has been on 802.11b, 802.11a, and HIPERLAN Type 2.

Testing is an important part of the design and manufacturing process. This is especially true in wireless LAN systems when interoperability is a goal. Although the application note has mostly considered testing of the transmitted signal, receiver testing is equally important. What may not be obvious is that most of the measurements discussed in this paper are very important for receiver testing and troubleshooting. For example, if a receiver fails a sensitivity test, it could be because of the receiver, a problem with the signal used to perform the test, or other factors.

Measurement tools are available to speed the development process by providing diagnostic capabilities, which can help to quickly isolate the source of a problem, whether it is in the transmitter or receiver, at RF or baseband. An Agilent 89600 Series VSA can measure signal quality at many points in the system. These points include baseband (I/Q), IF, and RF, in both the transmitter up-conversion signal path and the receiver down-conversion signal path. If there is a problem with a receiver and there is confidence in the quality of the signal going into the receiver, then it would be useful to make many of the measurements described in this paper at test points within the receiver's signal path. One such example is a spectrum measurement at the output of an analog IQ demodulator, just before the receiver digitizes the signal. Using a 2-channel Agilent 89610A VSA in ch1+jch2 mode, the baseband signal can be checked for spurious error, adjacent channel leakage, receiver-induced phase noise, EVM, etc. A single RF channel Agilent 89610A VSA can be used at IF and RF frequencies.

Acronym glossary

(D)BPSK – Differential Binary Phase Shift Keying

(D)QPSK – Differential Quadrature Phase Shift Keying

ADC – Analog-to-Digital Converter

Agilent ADS – Agilent Advanced Design System

ADSL – Asynchronous Digital Subscriber Line

AP – Access Point

AWGN – Additive White Gaussian Noise

BPSK – Binary Phase Shift Keying

CCDF – Complementary Cumulative Distribution Function

CCK – Complementary Code Keying

CDF – Cumulative Distribution Function

CDMA – Code Division Multiple Access

CRC – Cyclic Redundancy Code

DAB – Digital Audio Broadcast

DAC – Digital-to-Analog Converter

DSP – Digital Signal Processing

DSSS – Direct Sequence Spread Spectrum

EIRP – Effective Isotropic Radiated Power

EQ – Equalizer

ESG – Electronic Signal Generator

ETSI – European Telecommunications Standards Institute

EVM – Error Vector Magnitude

FFT – Fast Fourier Transform

FHSS – Frequency Hopping Spread Spectrum

FM – Frequency Modulation

FSK – Frequency Shift Keying

GFSK – Gaussian Frequency Shift Keying

GMSK – Gaussian Minimum Shift Keying

GSM – Global System for Mobile Communications

HIPERLAN – High Performance Radio Local Area Network

I/Q – In-phase/Quadrature

ICI – Inter-Carrier Interference

IF – Intermediate Frequency

IFFT – Inverse Fast Fourier Transform

IS-95 – cdmaOne Cellular Phone Communications Standard

ISI – Inter-Symbol Interference

ISM – Industrial, Scientific and Medical band

LAN – Local Area Network

LO – Local Oscillator

MAC – Medium Access Control

MPDU – MAC sublayer protocol data units

MSK – Minimum Shift Keying

OFDM – Orthogonal Frequency Division Multiplexing

PA – Power Amplifier

PAR – Peak-to-Average Ratio

PCMCIA – Personal Computer Memory Card International Association

PLCP – Physical Layer convergence procedure

PMD – physical medium dependent

PPDU – PHY protocol data units

PSDU – PLCP service data units

PSK – Phase Shift Keying

QAM – Quadrature Amplitude Modulation

QPSK – Quadrature Phase Shift Keying

RF – Radio Frequency

RMS – Root Mean Square

RX – Receiver

SCM – Single Carrier Modulation

SFD – Start Frame Delimiter

TDMA – Time Division Multiple Access

TX – Transmitter

VOFDM – Vector Orthogonal Frequency Division Multiplexing

Wi-Fi – 802.11b certification

WLAN – Wireless Local Area Network

Wireless LAN Standards Summary Table

	Wireless LAN Standards				
	802.11	802.11b	802.11a	HIPERLAN Type 1	HYPERLAN Type 2
Frequency band	2.4 GHz	2.4 GHz	5 GHz	5 GHz	5 GHz
Channel separation	25 MHz for DSSS, 1 MHz for FHSS	25 MHz	20 MHz	23.5 MHz	20 MHz
Maximum raw data rate	2 Mbit/s	11 Mbit/s	54 Mbit/s	23.5 Mbit/s	54 Mbit/s
Carrier Type	FHSS or DSSS	DSSS	OFDM	single carrier	OFDM
Modulation	GFSK (FHSS), DBPSK or DQPSK (DSSS)	CCK	BPSK & QPSK, 16 QAM, or 64 QAM	FSK or GMSK	BPSK & QPSK, 16 QAM, or 64 QAM
Number of carriers per channel	79 ²	1 (DSSS)	48 data & 4 pilot	1	48 data & 4 pilot
Maximum power output	30 dBm	30 dBm	35 dBm ¹	30 dBm ¹	30 dBm ¹

¹ Effective Isotropic Radiated Power (EIRP)

² Indicates number of operating channels for FHSS in USA

Related Literature

Agilent 89600 Series Vector Signal Analyzers

Configuration Guide, literature number 5968-9350E

Agilent 89610A dc to 40 MHz Vector Signal Analyzer,

Technical Specifications, literature number 5980-1259E

Agilent 89640A dc to 2700 MHz Vector Signal Analyzer,

Technical Specifications, literature number 5980-1258E

Digital Modulation in Communication Systems-An Introduction,

Application Note 1298, literature number 5965-7160E

Testing and Troubleshooting Digital RF Communications Transmitter Designs,

Application Note 1313, literature number 5968-3578E

Testing and Troubleshooting Digital RF Communications Receiver Designs,

Application Note 1314, literature number 5968-3579E

Using Vector Modulation Analysis in the Integration, Troubleshooting and

Design of Digital RF Communications Systems,

Product Note, literature number 5091-8687E

Using Error Vector Magnitude Measurements to Analyze and Troubleshoot Vector-Modulated Signals,

Product Note, literature number 5965-2898E

10 Steps to a Perfect Digital Demodulation Measurement,

Product Note, literature number 5966-0444E

To stay up to date on Wireless LAN and *Bluetooth*[™], please visit www.agilent.com/find/wlan

Agilent Technologies' Test and Measurement Support, Services, and Assistance

Agilent Technologies aims to maximize the value you receive, while minimizing your risk and problems. We strive to ensure that you get the test and measurement capabilities you paid for and obtain the support you need. Our extensive support resources and services can help you choose the right Agilent products for your applications and apply them successfully. Every instrument and system we sell has a global warranty. Support is available for at least five years beyond the production life of the product. Two concepts underlie Agilent's overall support policy: "Our Promise" and "Your Advantage."

Our Promise

Our Promise means your Agilent test and measurement equipment will meet its advertised performance and functionality. When you are choosing new equipment, we will help you with product information, including realistic performance specifications and practical recommendations from experienced test engineers. When you use Agilent equipment, we can verify that it works properly, help with product operation, and provide basic measurement assistance for the use of specified capabilities, at no extra cost upon request. Many self-help tools are available.

Your Advantage

Your Advantage means that Agilent offers a wide range of additional expert test and measurement services, which you can purchase according to your unique technical and business needs. Solve problems efficiently and gain a competitive edge by contracting with us for calibration, extra-cost upgrades, out-of-warranty repairs, and on-site education and training, as well as design, system integration, project management, and other professional engineering services. Experienced Agilent engineers and technicians worldwide can help you maximize your productivity, optimize the return on investment of your Agilent instruments and systems, and obtain dependable measurement accuracy for the life of those products.

By internet, phone, or fax, get assistance with all your test & measurement needs

Online assistance:

www.agilent.com/find/assist

Phone or Fax

United States:

(tel) 1 800 452 4844

Canada:

(tel) 1 877 894 4414

(fax) (905) 282 6495

China:

(tel) 800 810 0189

(fax) 1 0800 650 0121

Europe:

(tel) (31 20) 547 2323

(fax) (31 20) 547 2390

Japan:

(tel) (81) 426 56 7832

(fax) (81) 426 56 7840

Korea:

(tel) (82 2) 2004 5004

(fax) (82 2) 2004 5115

Latin America:

(tel) (305) 269 7500

(fax) (305) 269 7599

Taiwan:

(tel) 080 004 7866

(fax) (886 2) 2545 6723

Other Asia Pacific Countries:

(tel) (65) 375 8100

(fax) (65) 836 0252

(e-mail) tm_asia@agilent.com

Bluetooth and the *Bluetooth* logos are trademarks owned by the *Bluetooth* SIG, Inc., U.S.A. and licensed to Agilent Technologies, Inc.

Product specifications and descriptions in this document subject to change without notice.

© Agilent Technologies, Inc. 2001

Printed in the USA September 29, 2001

5988-3762EN



Agilent Technologies